

# VEGAS 2

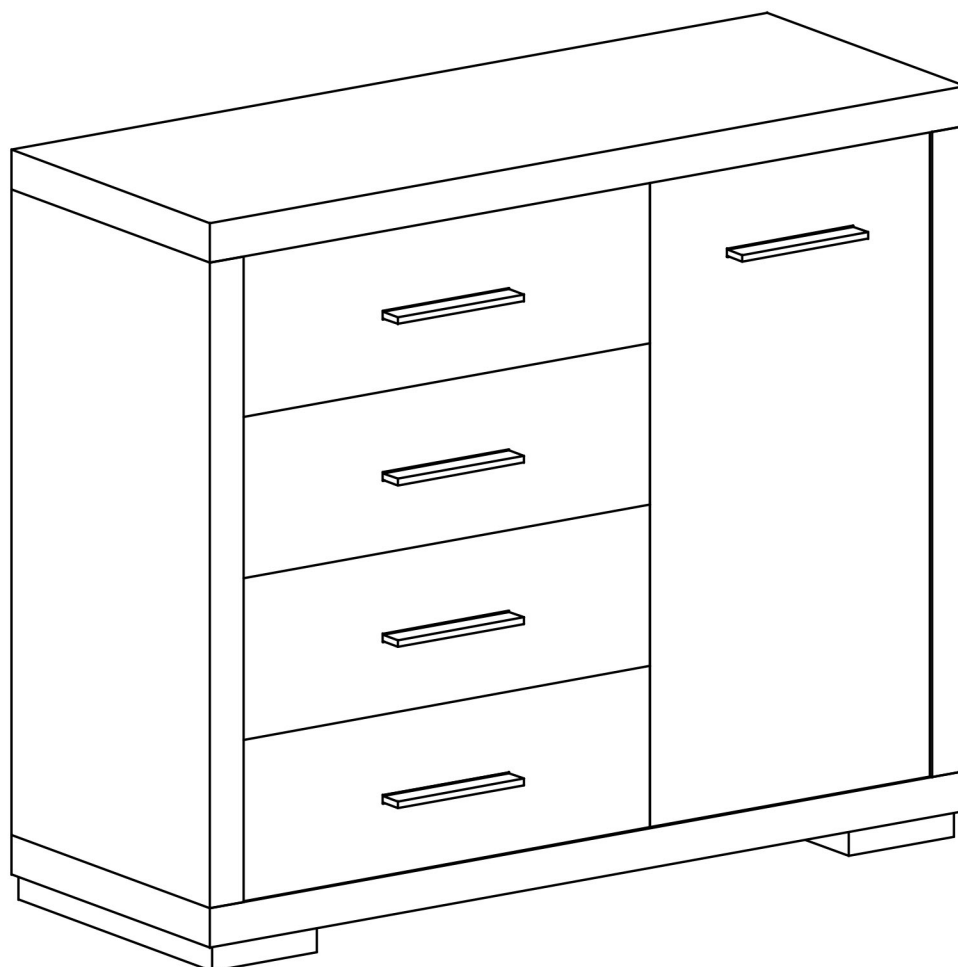

Nr	D[mm]	S[mm]	G[mm]	
1	1082	407	48	1
2	1082	407	48	1
3	783	405	48	1
4	780	388	16	1
5	783	405	48	1
6	394	320	16	1
7	773	368	16	1
8	1070	834	2,5	1
9	603	190	16	4
10	546	165	16	4
11	350	165	16	4
12	350	165	16	4
13	575	355	2,5	4

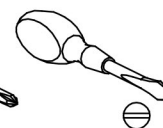
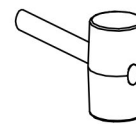
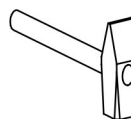
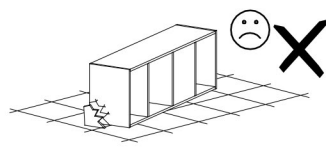
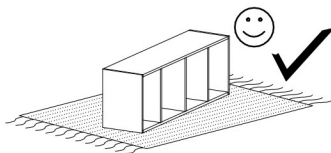
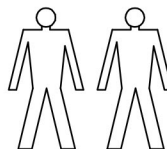
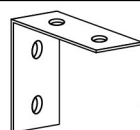

**Y - 1 St.**

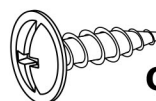

**Q - 2 St.**  
3,5x16 mm

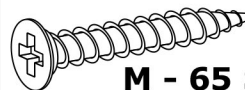

**M - 65 St.**  
3x30 mm

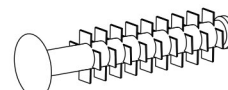

**F - 16 St.**



**X2 - 20 St.**

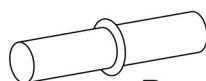

**P - 4 St.**

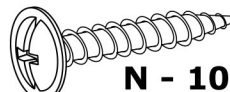

**N - 10 St.**  
4x27 mm

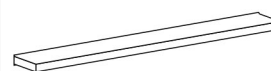

**U - 5 St.**



**G - 4 St.**  
3,5x16 mm



**H - 6 St.**  
4x60 mm

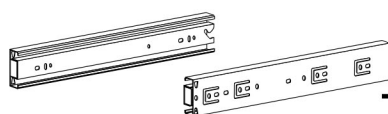

**T - 4 Kpl.**

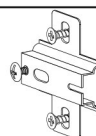

**C - 2 St.**

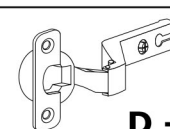

**D - 2 St.**



**L - 20 St.**

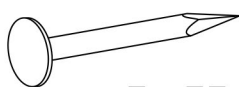

**E - 55 St.**

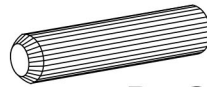

**B - 28 St.**

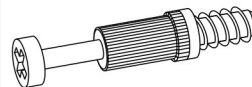

**K - 20 St.**

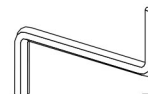

**Z - 1 St.**

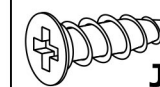

**J - 32 St.**  
5x13 mm

I

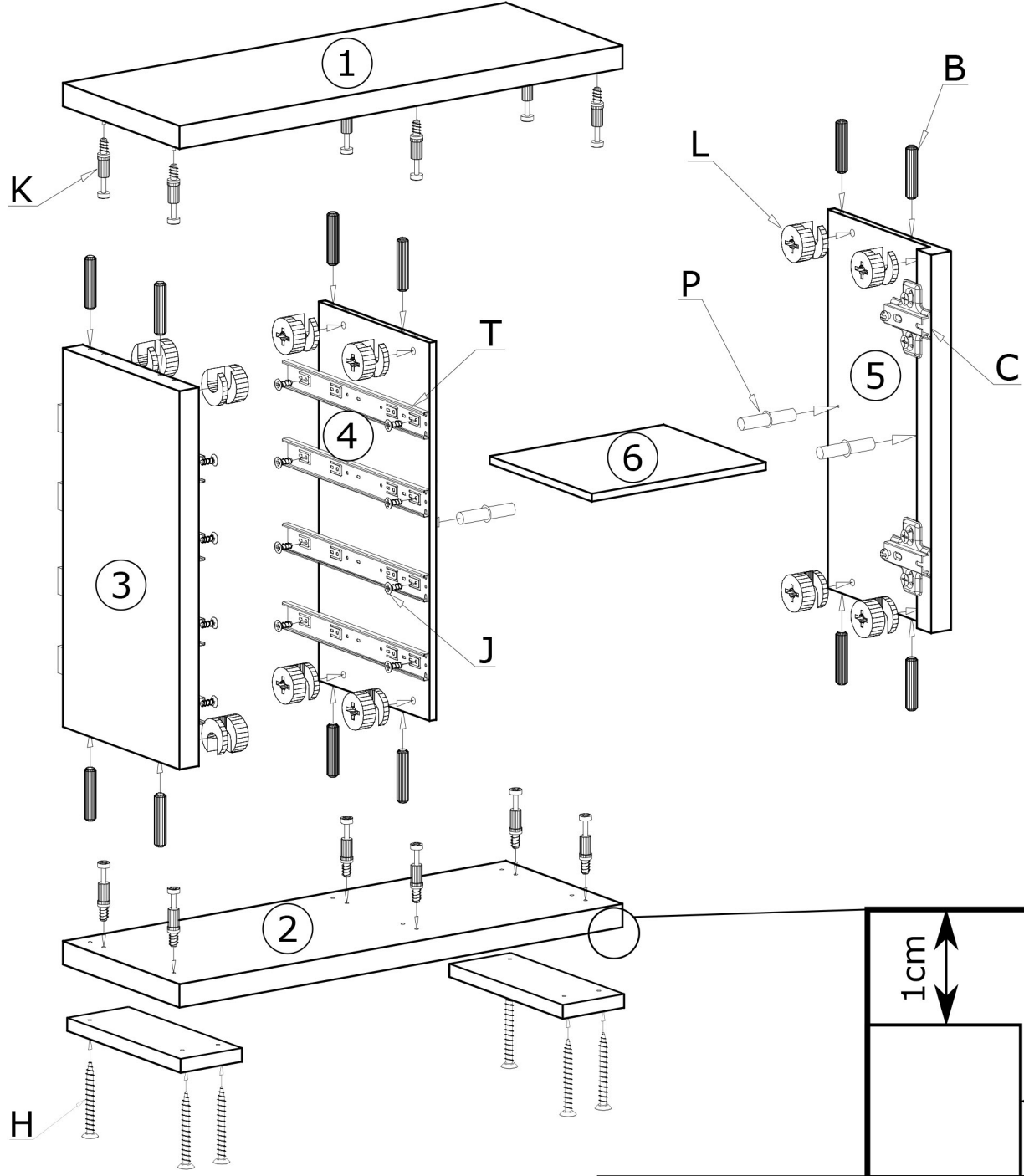

II

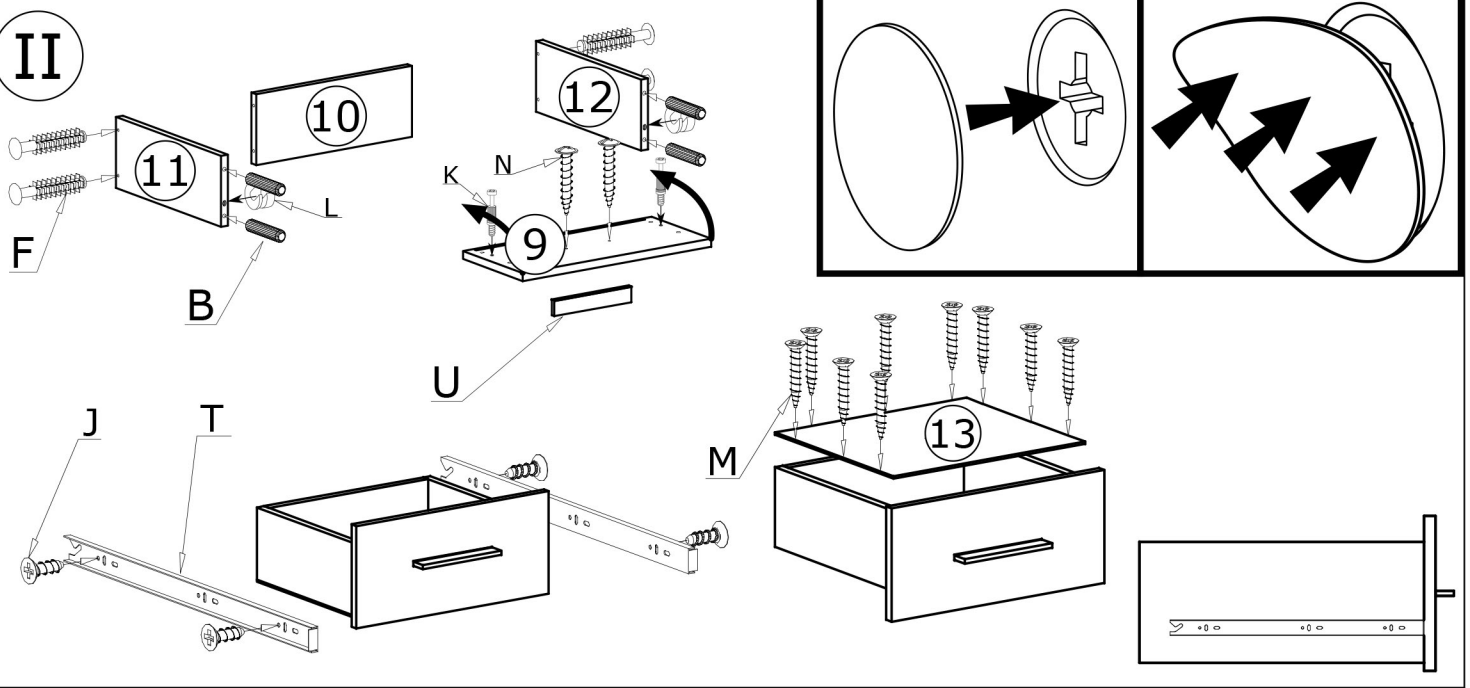

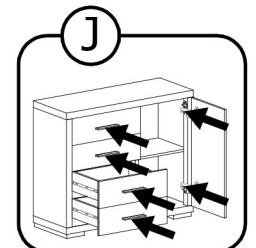
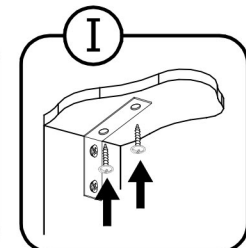
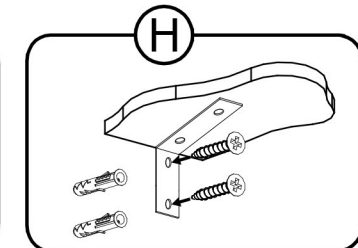
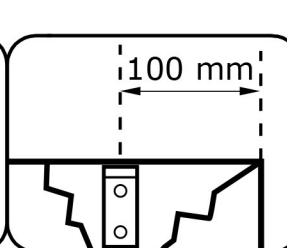
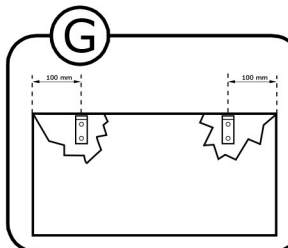
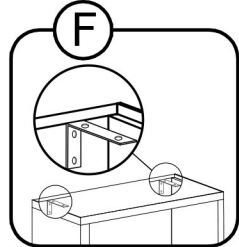
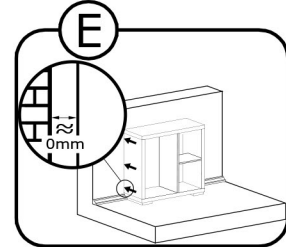
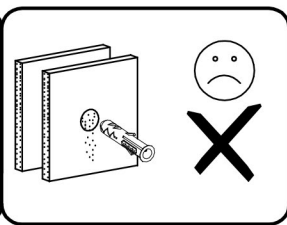
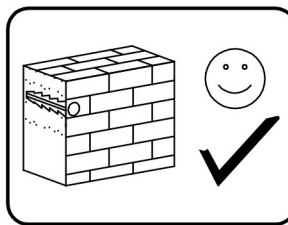
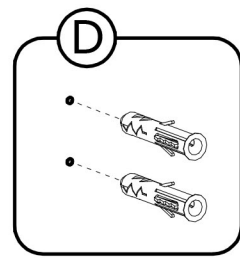
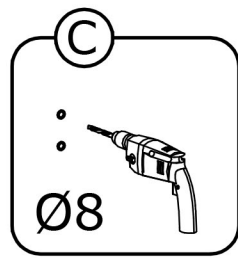
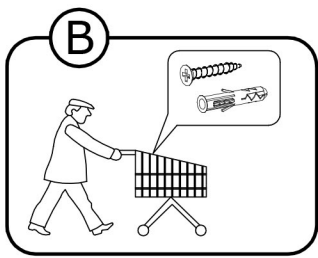
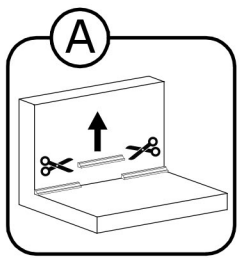
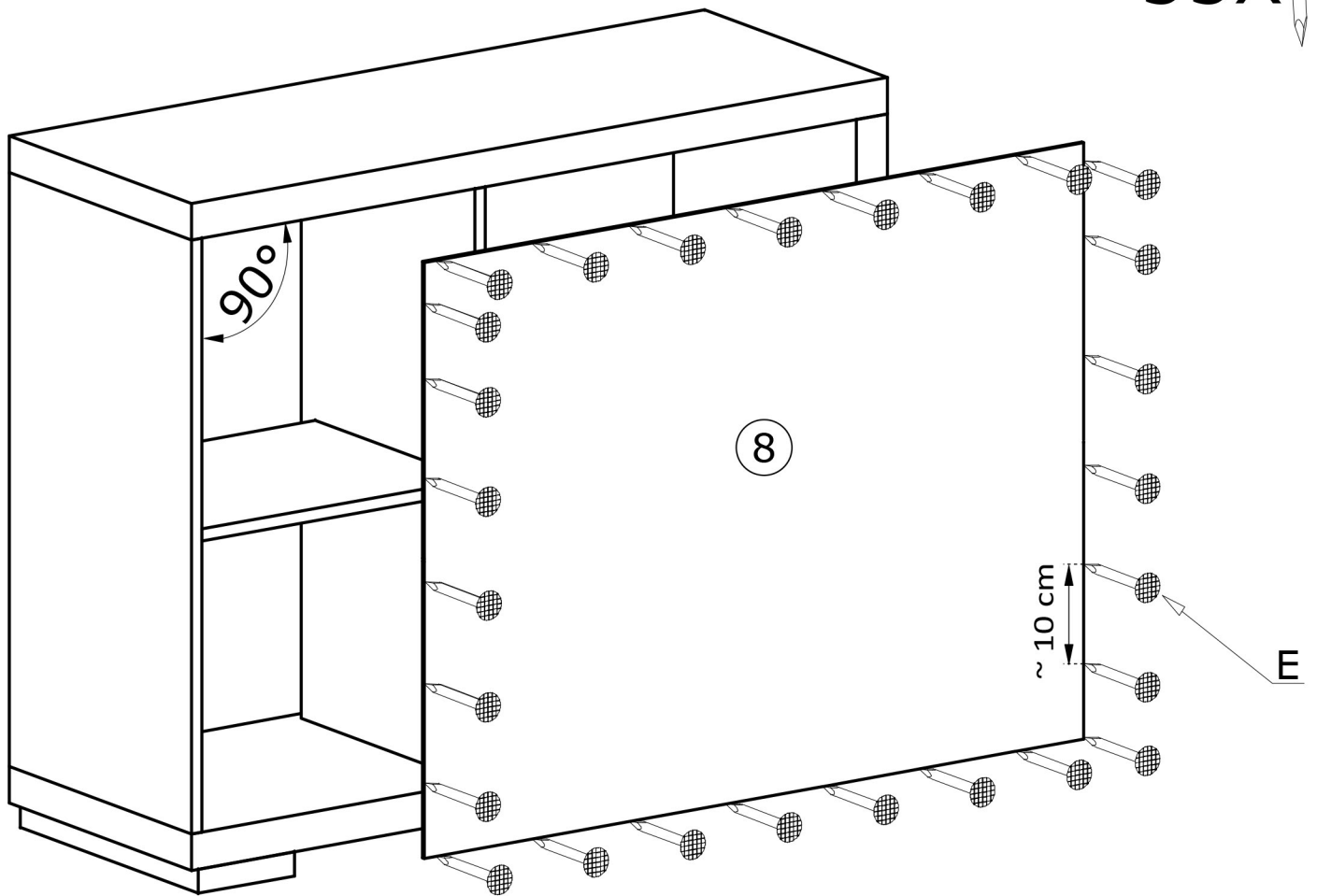

IV

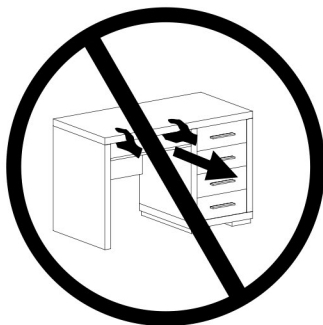
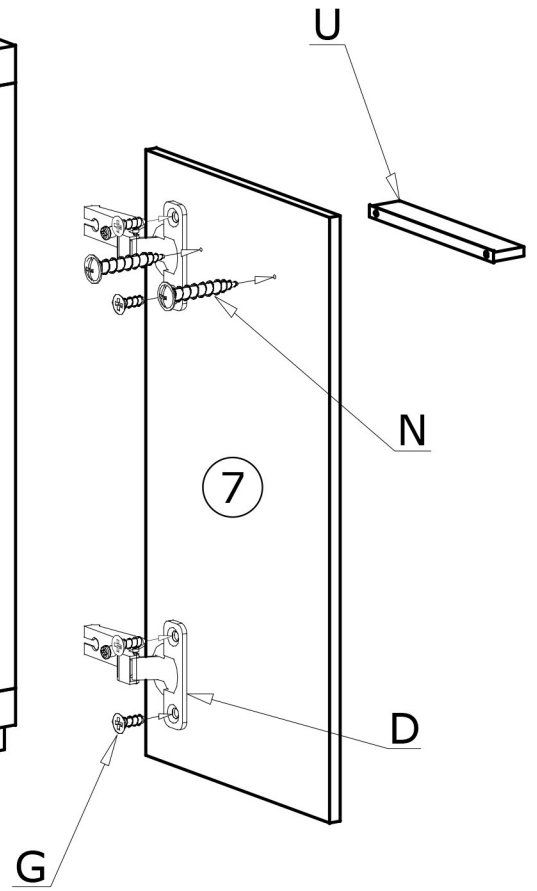
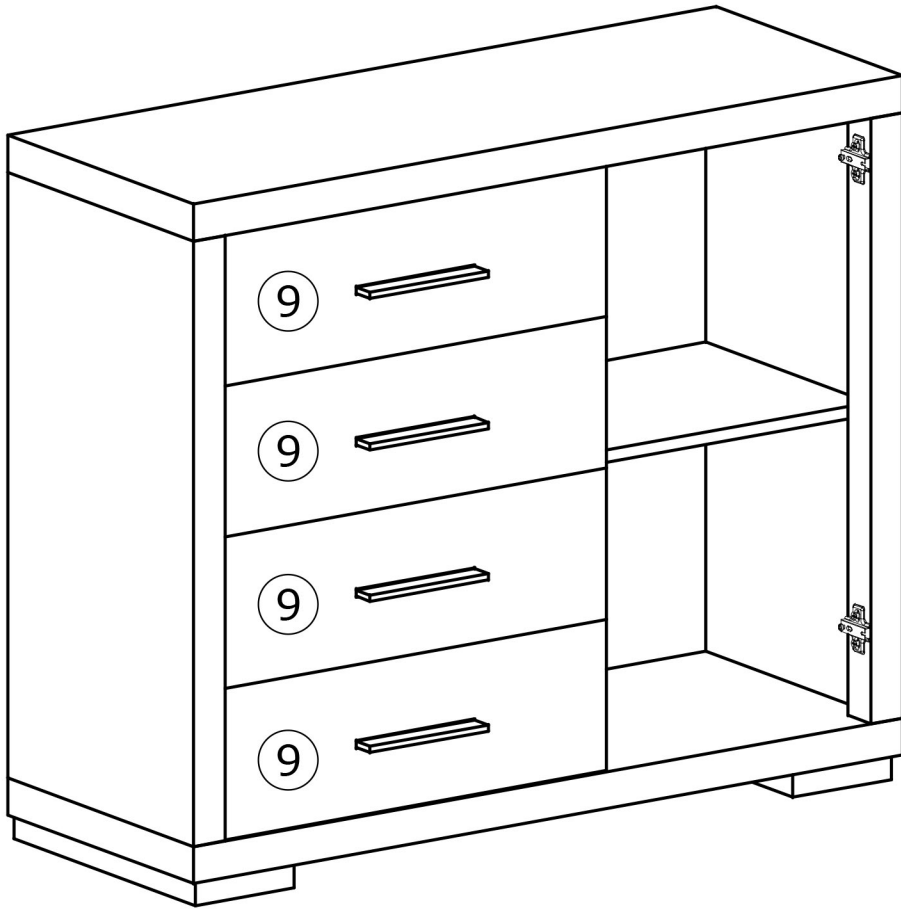
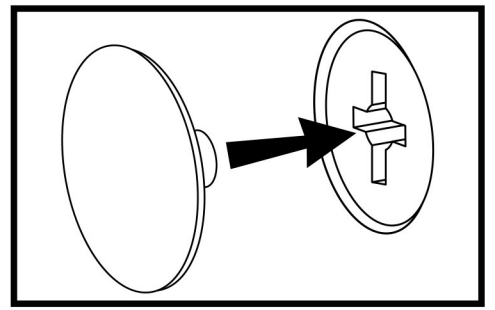



1



2

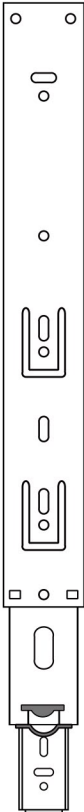

3

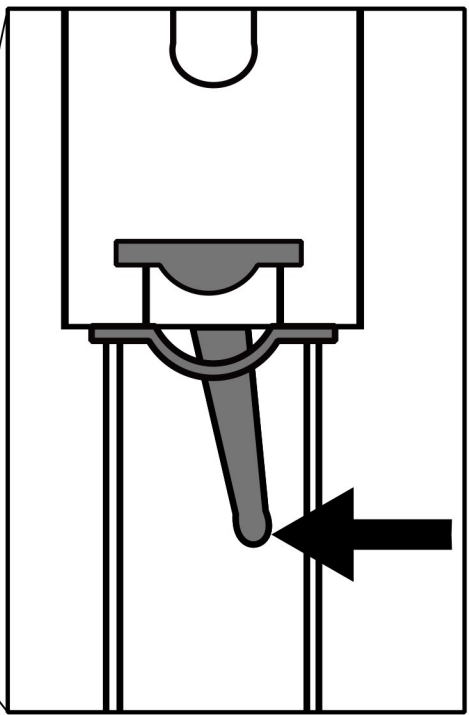

4

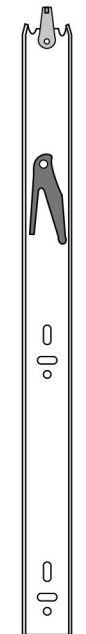
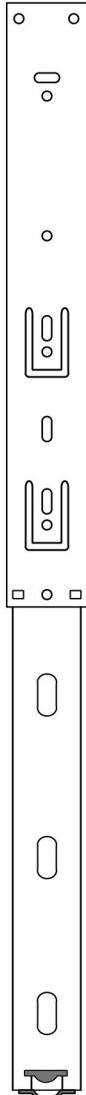

PL

**UWAGA!!!**

MONTOWANIE USZKODZONYCH ELEMENTÓW POWODUJE UTRATĘ GWARANCJI

**UWAGA!!!**

MEBEL ZAWIERA ELEMENTY DREWNIANE

W PRZYPADKU REKLAMACJI PROSZĘ PODAĆ NUMER PAKOWACZA ZNAJDUJĄCY SIĘ NA KARTONIE  
ODCIEŃ DREWNA I UKŁAD SŁOI MOGĄ NIEZNACZNIE ODBIEGAĆ OD PREZENTOWANYCH NA ZDJĘCIACH KATALOGOWYCH

CZ

**UPOZORNĚNÍ!!!**

MONTÁŽ POŠKOZENÝCH KOMPONENTŮ RUŠÍ PLATNOU ZÁRUKU

**UPOZORNĚNÍ!!!**

NÁBYTEK OBSAHUJE DŘEVĚNÉ PRVKY

V PŘÍPADĚ REKLAMACE UVEĎTE PROSÍM ČÍSLO BALIČE, KTERÉ NAJDETE NA KRABICI  
ODSTÍN A KRESBA DŘEVA SE MOHOU VÝRAZNĚ LIŠIT  
OD TĚCH ZOBRAZENÝCH NA KATALOGOVÝCH FOTOGRAFIÍCH

DE

**BEACHTUNG!!!**

DER EINBAU BESCHÄDIGTER KOMPONENTEN SCHLIESST EINE GÜLTIGE GEWÄHRLEISTUNG AUS

**BEACHTUNG!!!**

MÖBEL ENTHALTEN HOLZELEMENTE

IM FALL EINER REKLAMATION GEBEN SIE BITTE DIE PAKETNUMMER AN,  
DIE SIE AUF DEM KARTON FINDEN  
HOLZSCHATTIERUNG UND HOLZZEICHNUNG KÖNNEN UNTERSCHIEDLICH  
VON DEN AUF DEN KATALOGFOTOS GEZEIGTEN ABWEICHEN

HR

**PAŽNJA!!!**

INSTALACIJA OŠTEĆENIH KOMPONENTI ZA POSLJEDICU IMA GUBITAK JAMSTVA

**PAŽNJA!!!**

NAMJEŠTAJ SADRŽI DRVENE ELEMENT

U SLUČAJU REKLAMACIJE, MOLIMO NAVESTI BROJ PAKIRANJA KOJI SE NALAZI NA KUTIJI  
NIJANSA DRVETA I RASPORED GODOVA MOGU MINIMALNO  
ODUDARATI OD ONIH NA KATALOŠKIM FOTOGRAFIJAMA

HU

**FIGYELEM!!!**

SÉRÜLT ALKATRÉSZEK BEÉPÍTÉSE ESETÉN A GARANCIA ÉRVÉNYÉT VESZTI

**FIGYELEM!!!**

A BÚTOROK FA ELEMÉKET TARTALMAZNAK

REKLAMÁCIÓ ESETÉN KÉRJÜK, ADJA MEG A DOBOZON TALÁLHATÓ CSOMAGOLÁSI SZÁMOT  
A FA ÁRNYALATA ÉS A CSOMÓK ELRENDEZÉSE  
JELENTŐSEN ELTÉRHET A KATALÓGUSBAN SZEREPLŐ KÉPEKTŐL

SK

**UPOZORNENIE!!!**

INŠTALÁCIU POŠKODENÝCH KOMPONENTOV SA RUŠÍ ZÁRUKA

**UPOZORNENIE!!!**

NÁBYTOK OBSAHUJE DREVENÉ PRVKY

V PRÍPADE REKLAMÁCIÍ UVEĎTE ČÍSLO BALENIA NÁJDENÉ NA KRABICI  
ODTIEŇ DŘEVA A USPORIADANIE UZLOV  
SA MÔŽE VÝRAZNĚ LIŠIŤ OD KATALÓGOVÝCH OBRÁZKOV

SR

**PAŽNJA!!!**

MONTAŽA OŠTEĆENIH DELOVA DOVODI DO GUBITKA GARANCIJE

**PAŽNJA!!!**

NAMEŠTAJ SADRŽI DRVENE DELOVE

U SLUČAJU REKLAMACIJA MOLIMO DA DOSTAVITE PAKER BROJ KOJI SE NALAZI NA KARTONU  
NIJANSA BOJE DRVETA I RASPORED SLOJEVA MOGU NEZNATNO  
DA SE RAZLIKUJU OD PREZENTOVANIH NA SLIKAMA U KATALOGU