

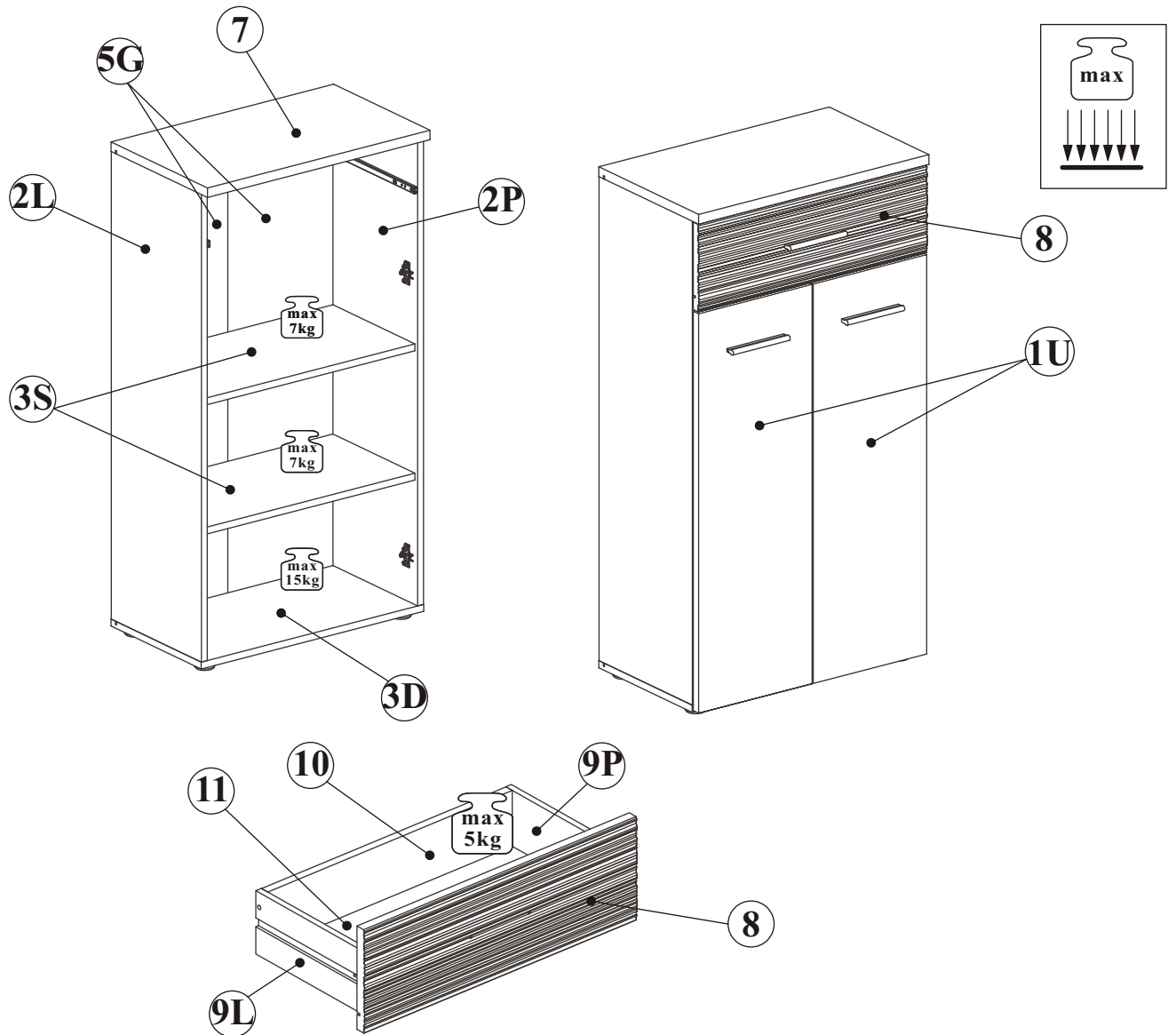

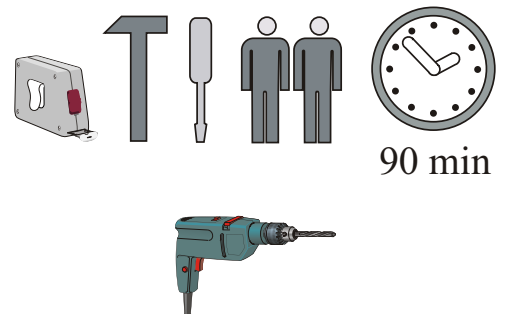







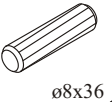
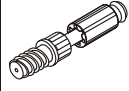

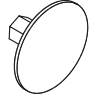
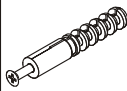
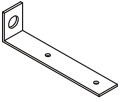
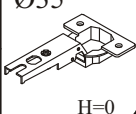
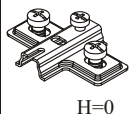
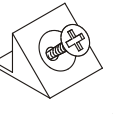

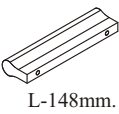
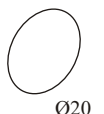

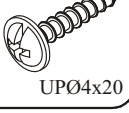
GUSTAVO TYP-G

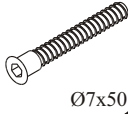

NO	Dim.			Col-No	Qty
1U	296	896	19	1	2
2L	1086	330	16	1	1
2P	1086	330	16	1	1
3D	601	330	16	1	1
3S	567	300	16	1	2
5G	1098	289,5	3	1	2
7	601	353	22	1	1
8	596	196	19	1	2
9L	280	120	12	1	1
9P	280	120	12	1	1
10	535	106	16	1	1
11	546	283	3	1	2

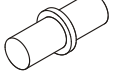

GUSTAVO TYP-G

A1 x12 	B4 x6 	B5 x4 	G5 x4 	KR1 x1 	L1 x1 
E21 x4 Ø35 H=0 	E2 x4 H=0 	S1 x13 	UP16 x6 UPØ4x35 	KL x3 L-148mm. 	G8 x2 Ø20 
UP13 x4 UPØ3x16 	I11 x4 Ø45, h=15 	UP11 x4 UPØ4x20 	D10 x10 USØ3,5x13 	G2 x1 	Z2 x4 Ø5 
B11 x6 Ø7x50 	G4 x6 	G7 x8 	H6 x1 L-280mm. 	D27 x4 ESØ6x8 	D18 x2 M4x9 
B7 x2 Ø15x10,3 					

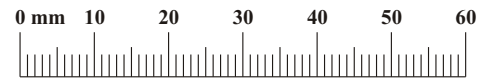

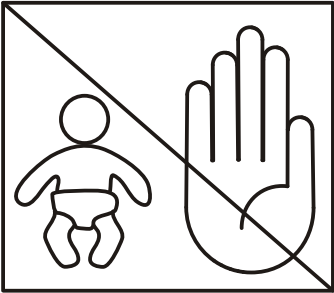

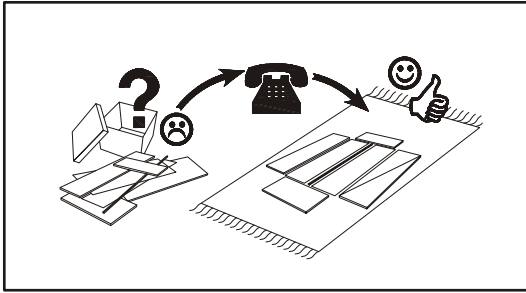

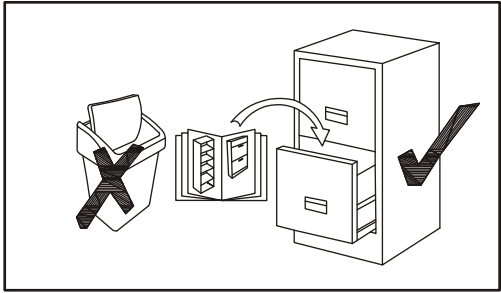

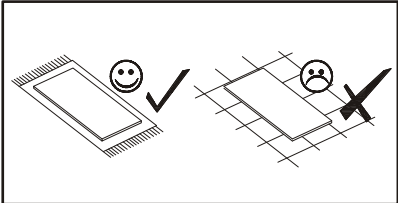

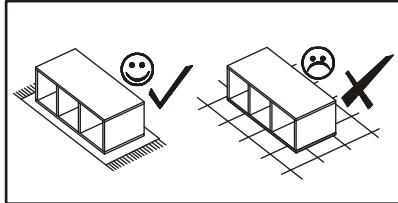

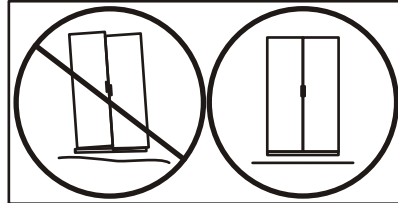

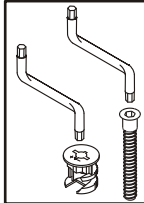







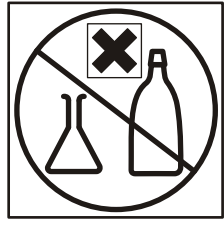

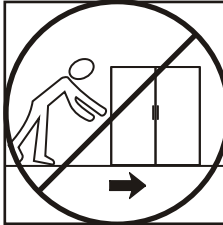

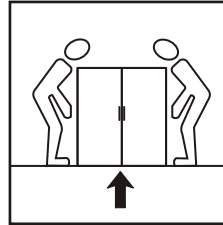

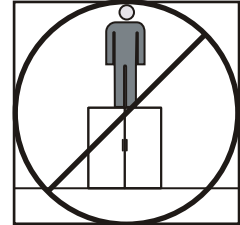

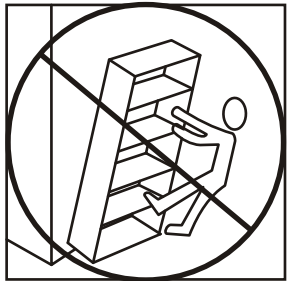

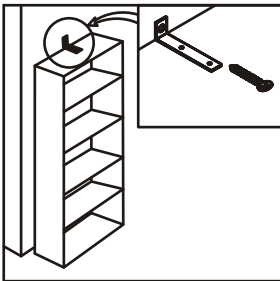





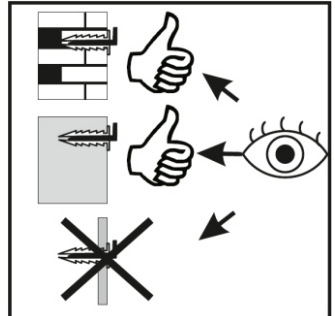

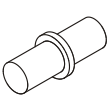
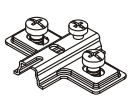
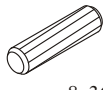
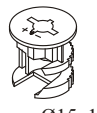

GUSTAVO TYP-G

1

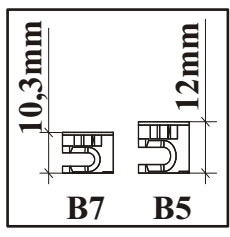
G7 x8		E2 x4 H=0		A1 x8 ø8x36		B5 x4 Ø15x12	
----------	---	-----------------	--	-------------------	---	--------------------	---



H6 x1 L-280mm.		D27 x4 ESØ6x8	
----------------------	---	---------------------	---

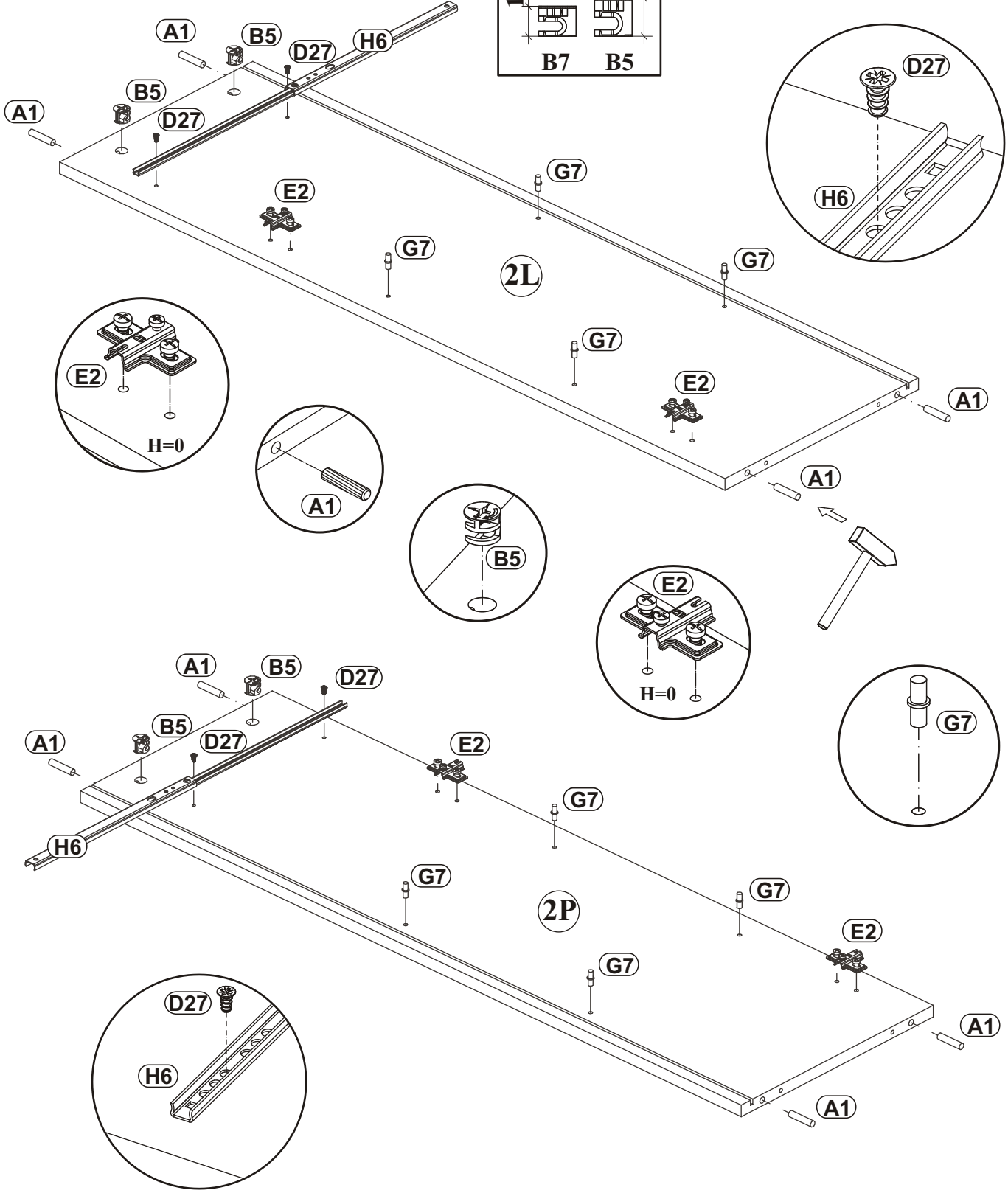

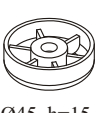
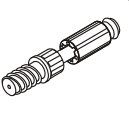

GUSTAVO TYP-G

2

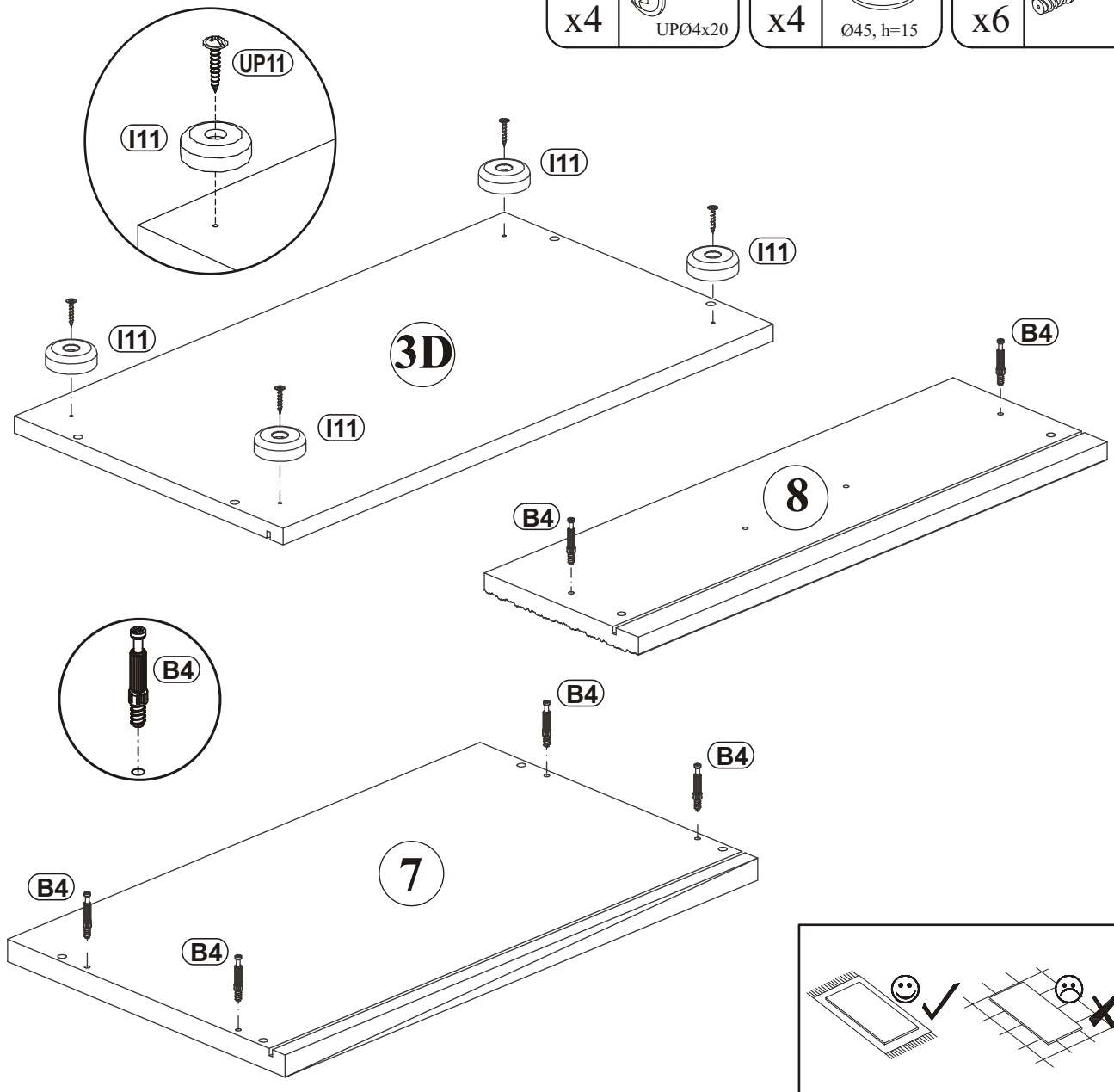

UP11		I11		B4	
x4	UPØ4x20	x4	Ø45, h=15	x6	

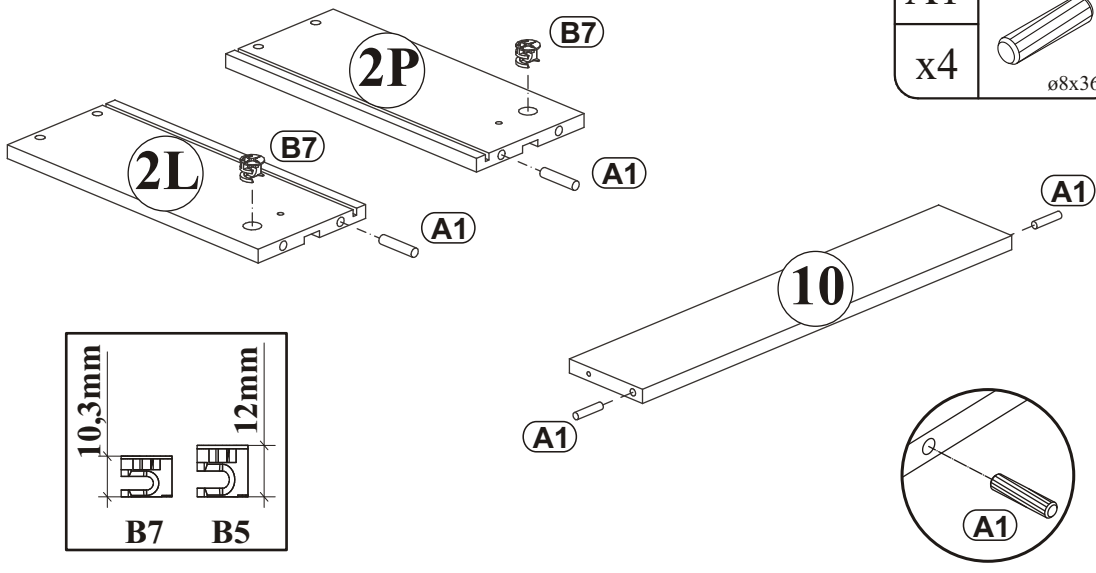

3

A1		B7	
x4	Ø8x36	x2	Ø15x10,3



10,3mm		12mm	
	B7		B5

GUSTAVO TYP-G

4

E21	Ø35	D10	 USØ3,5x13
x4	H=0	x8	

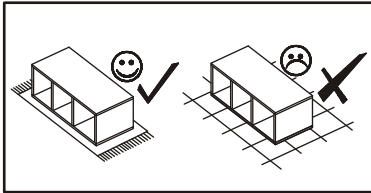
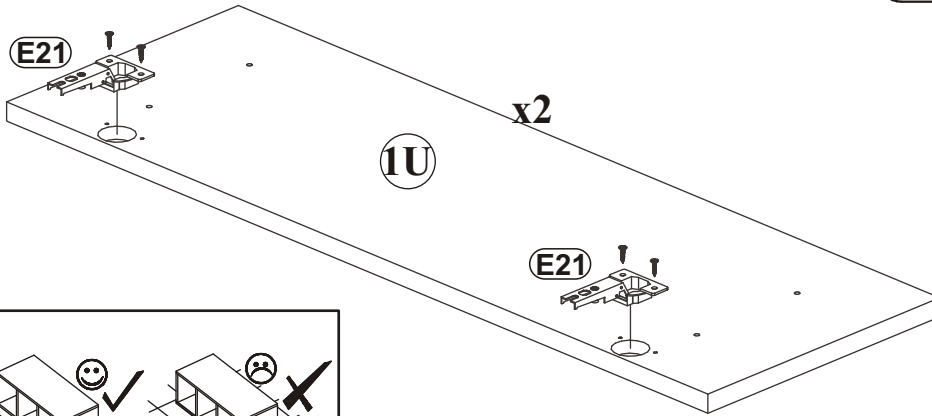

5

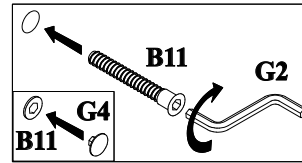

B11	 Ø7x50
x2	

G4	
x2	

G8	 Ø20
x2	

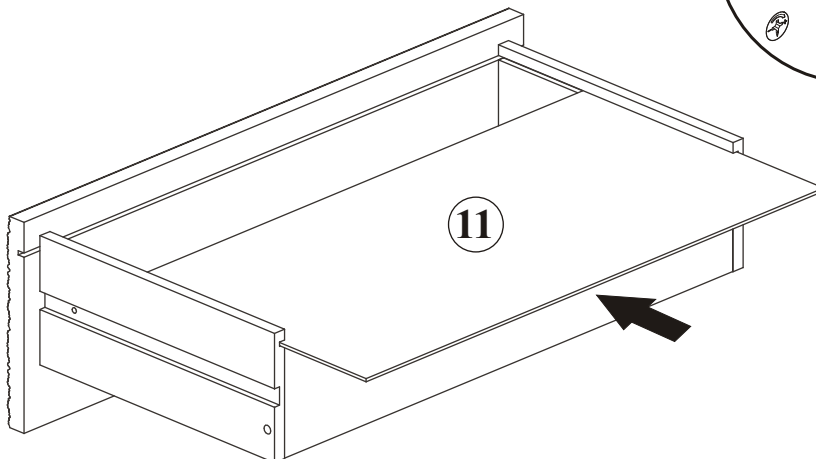
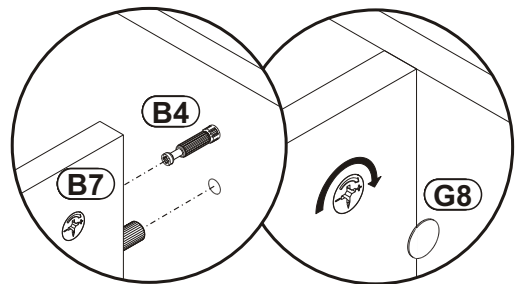
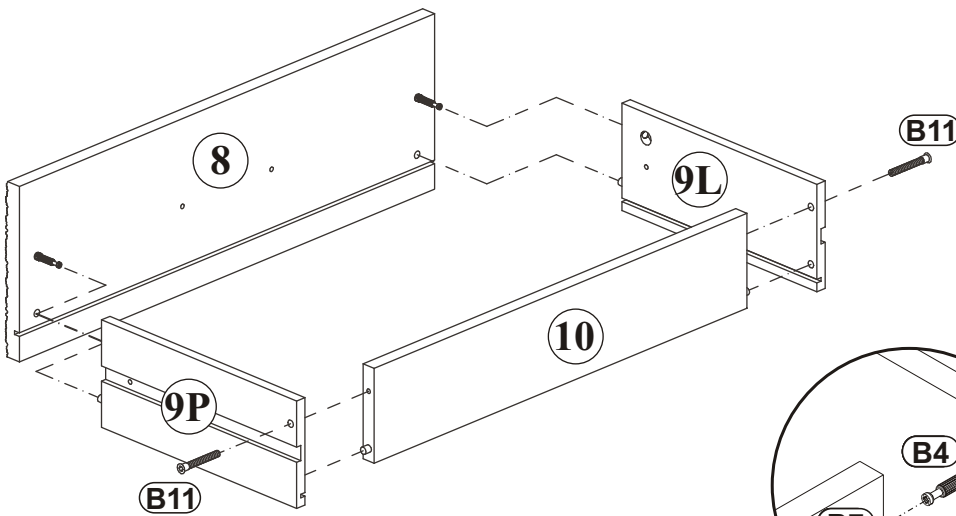

GUSTAVO TYP-G

6

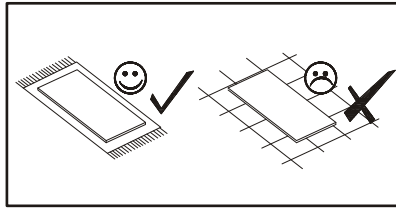

S1	
x1	

UP13	
x4	

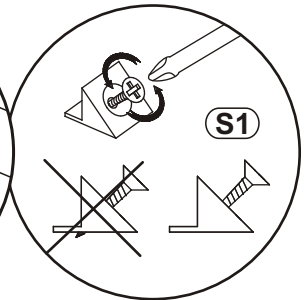
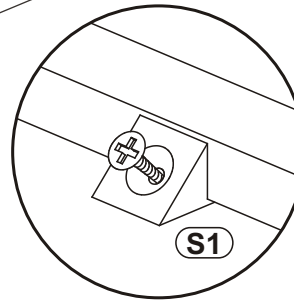
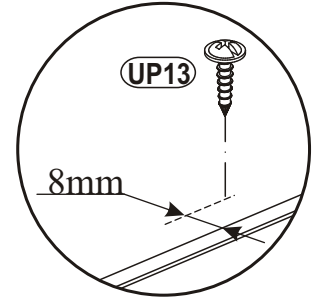
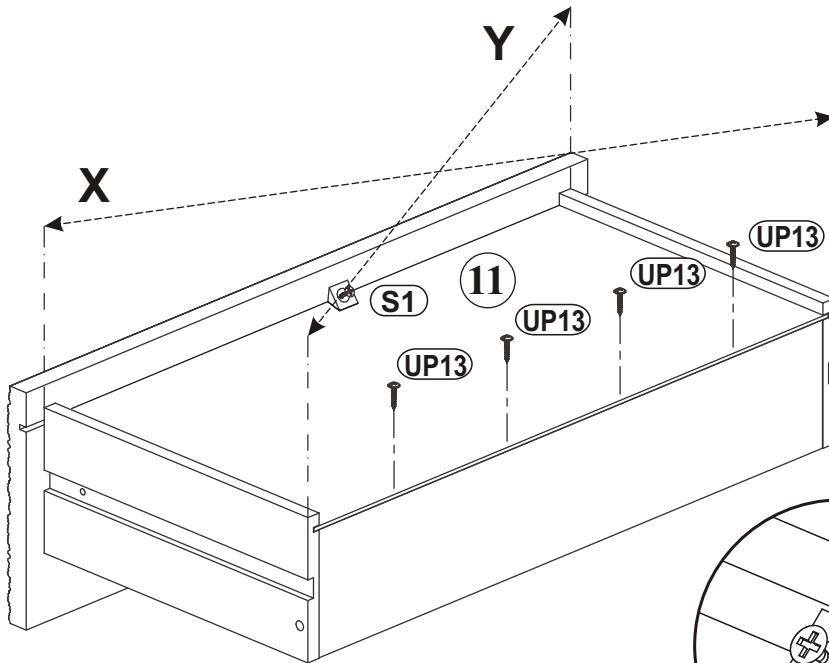

7

B11	
x4	$\varnothing 7 \times 50$

G4	
x4	

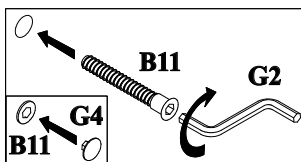
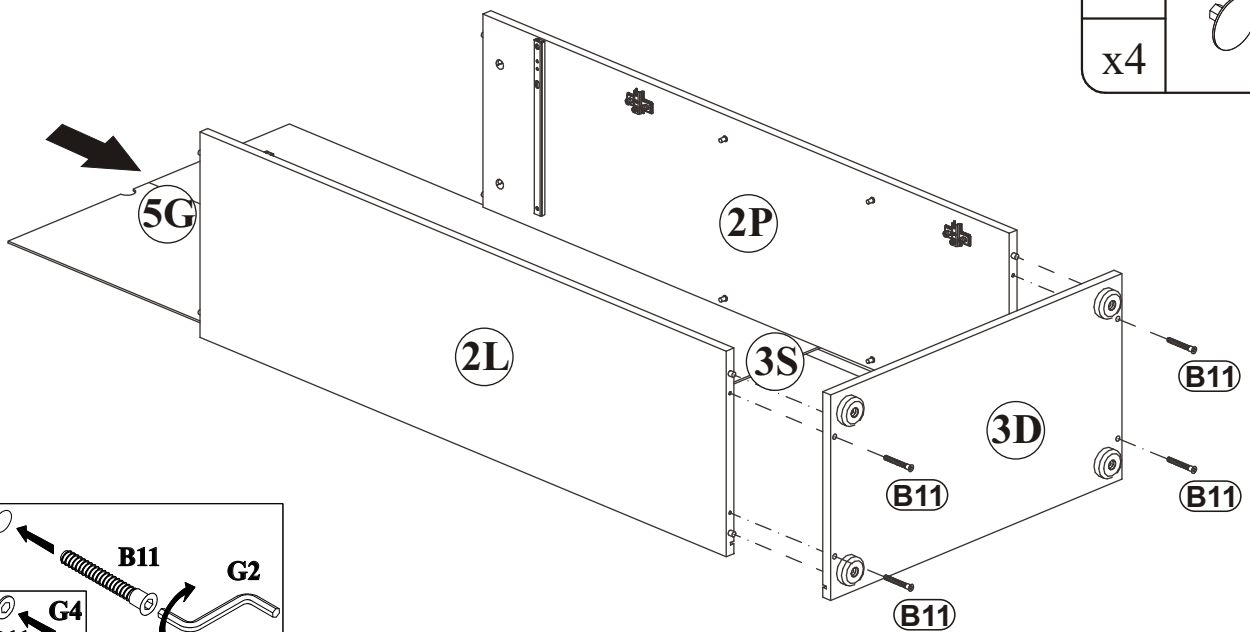

GUSTAVO TYP-G

8

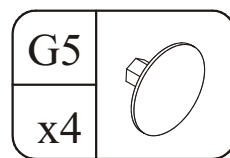
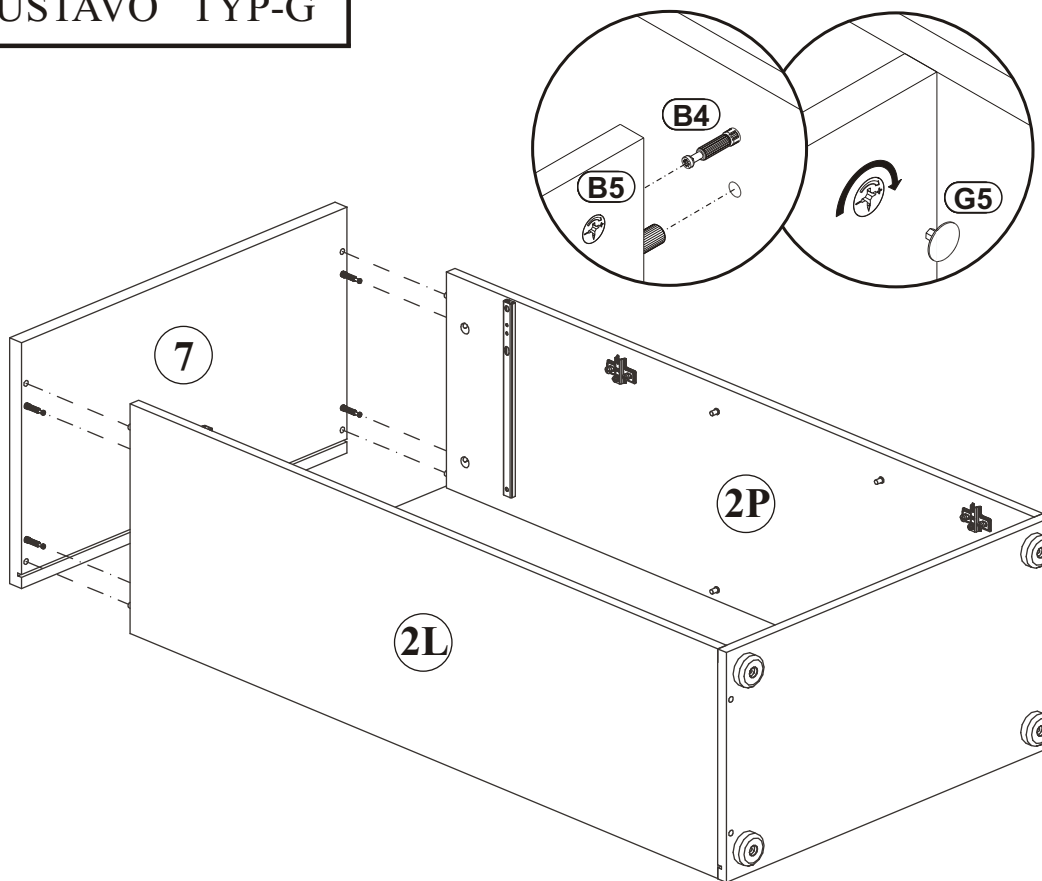

9

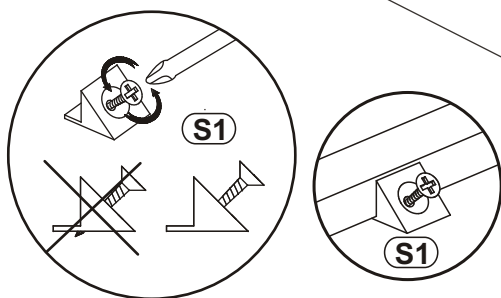
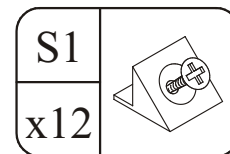
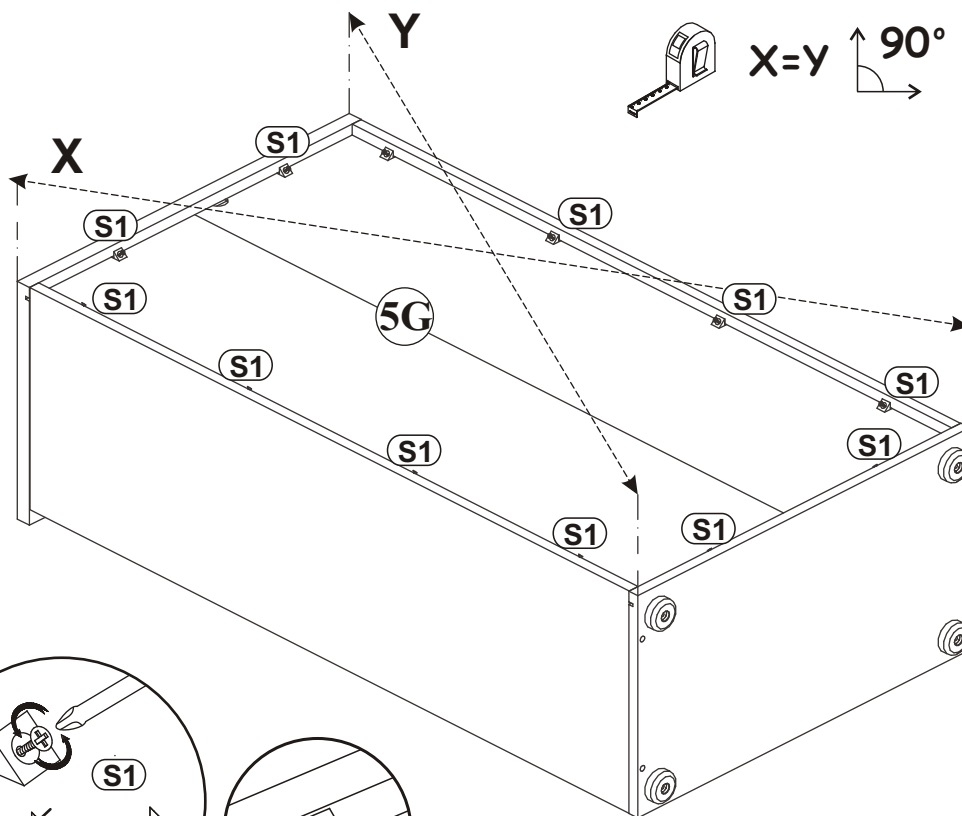

10

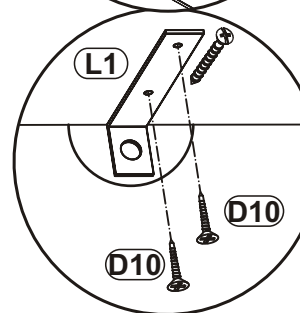
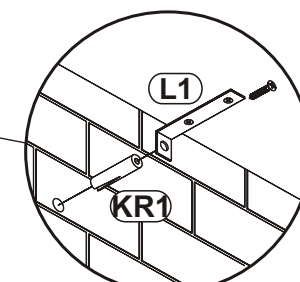
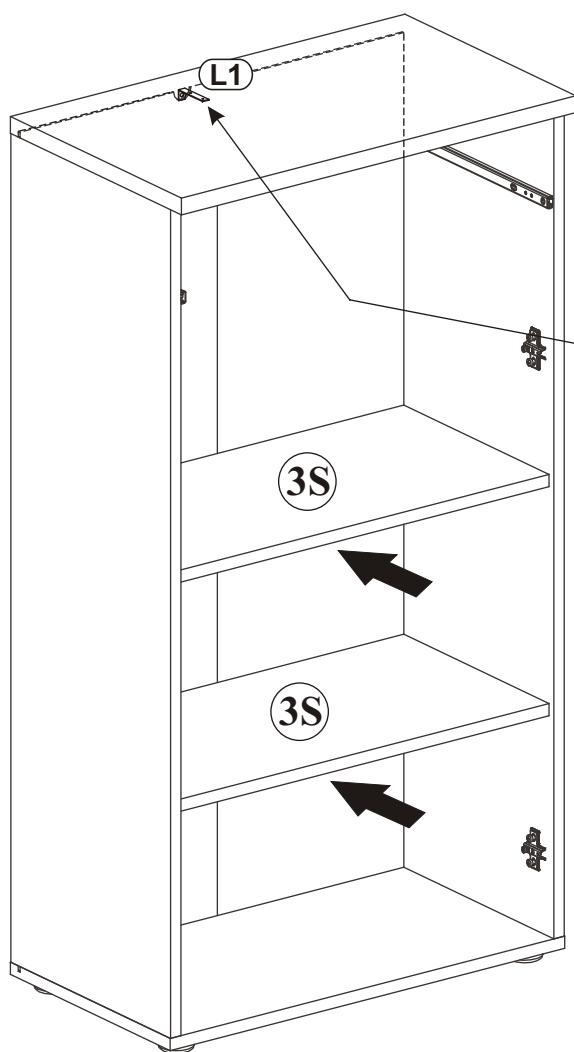
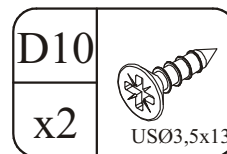
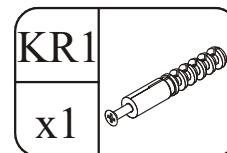
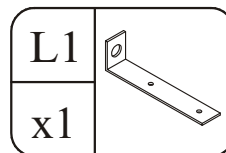
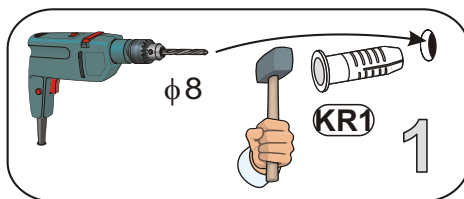
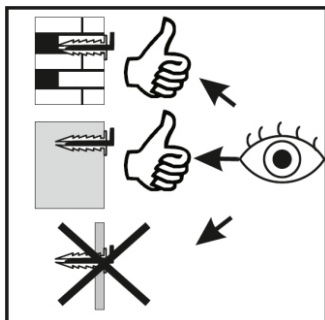

11

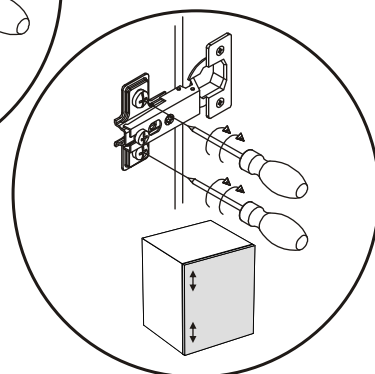
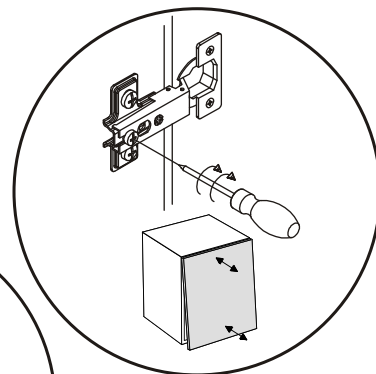
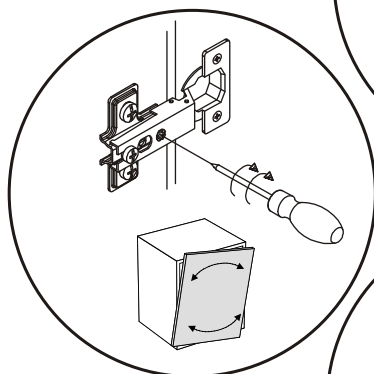
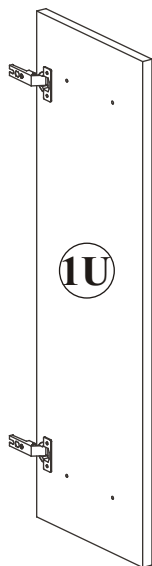
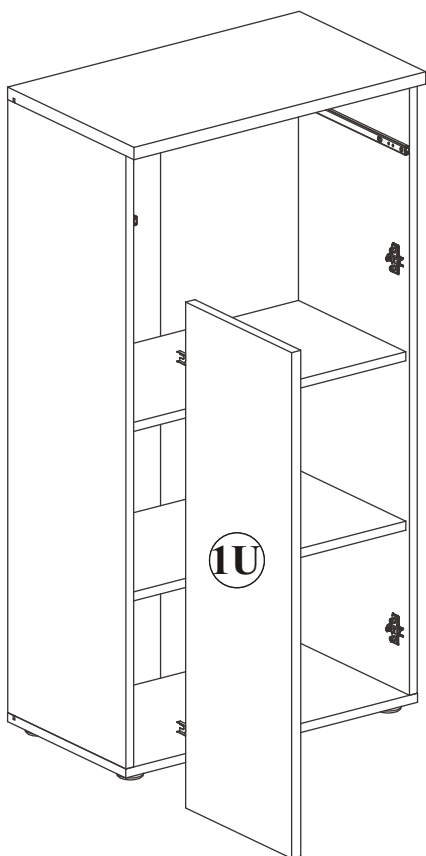

12

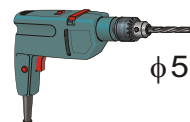
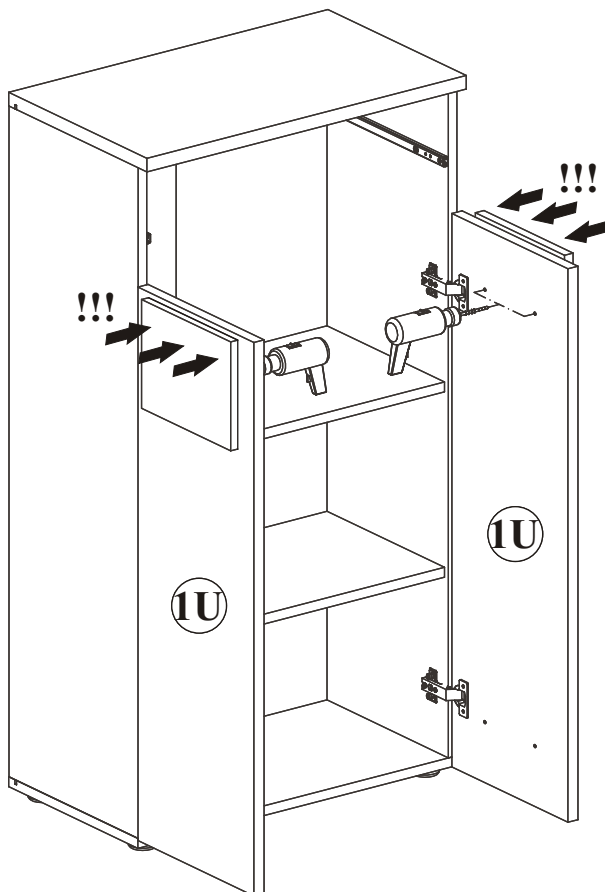

$\phi 5$

