

INDIANAPOLIS 22

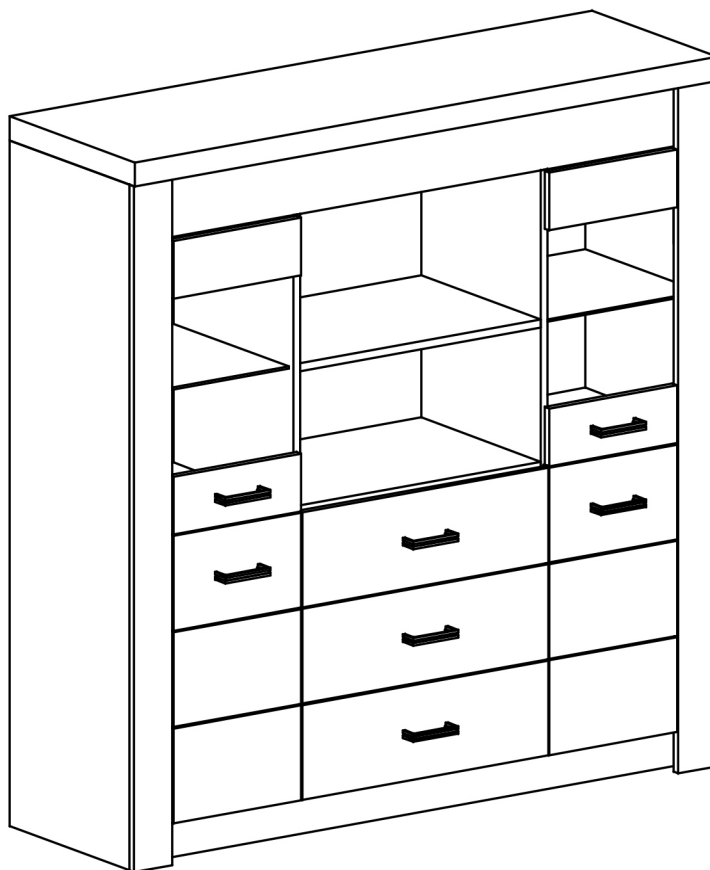

Nr	D[mm]	S[mm]	G[mm]	
1	618	403	16	1
2	1265	403	16	1
3	1265	403	16	1
4	1337	403	16	1
5	1337	80	16	1
6	1337	123	16	1
7	1361	403	16	1
8	1361	403	16	1
9	1361	80	16	1
10	1361	80	16	1
11	1370	422	48	1
12	635	190	16	3
13	350	150	16	3
14	350	150	16	3
15	560	150	16	3
16	590	355	2,5	3
17	1320	363	2,5	2
18	1320	632	2,5	1
19	344	403	16	2
20	280	120	16	1
21	280	120	16	1
22	385	275	4	2
23	280	120	16	1
24	280	120	16	1
25	344	380	4	2
26	618	380	16	1
27	344	380	16	2
28	578	280	16	1
29	578	280	16	1

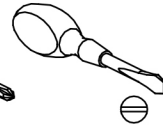
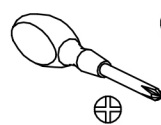
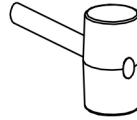
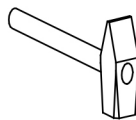
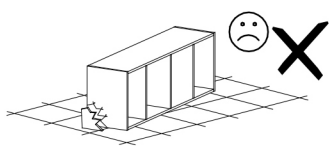
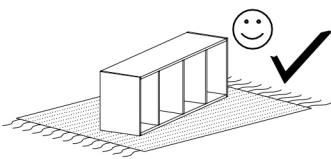
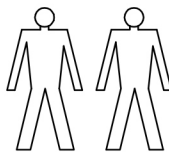

X2 - 9 St.



X1 - 24 St.

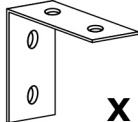

X - 1 St.

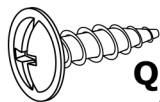

Q - 2 St.
3,5x16 mm

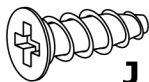

J - 24 St.
5x13 mm

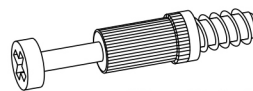

K - 24 St.

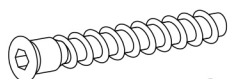

A - 9 St.

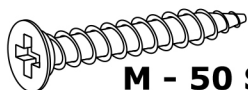

M - 50 St.
3x30 mm

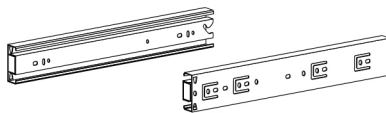

T - 3 Kpl.

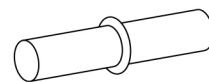

F - 12 St.

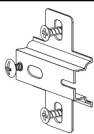

C - 8 St.

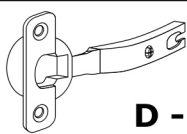

D - 8 St.



R - 12 St.

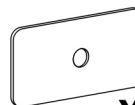

Y - 14 St.



E - 80 St.



I - 8 St.

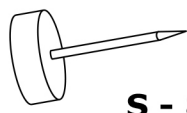

S - 8 St.

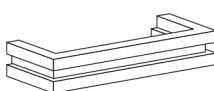

U - 7 St.

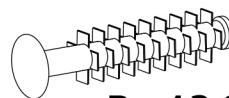

P - 12 St.

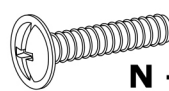

N - 14 St.
4x22 mm

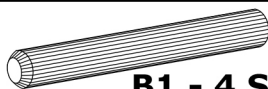

B1 - 4 St.
8x55 mm



B2 - 40 St.
8x35 mm



G - 42 St.
3,5x16 mm



Z - 1 St.



L - 24 St.

I

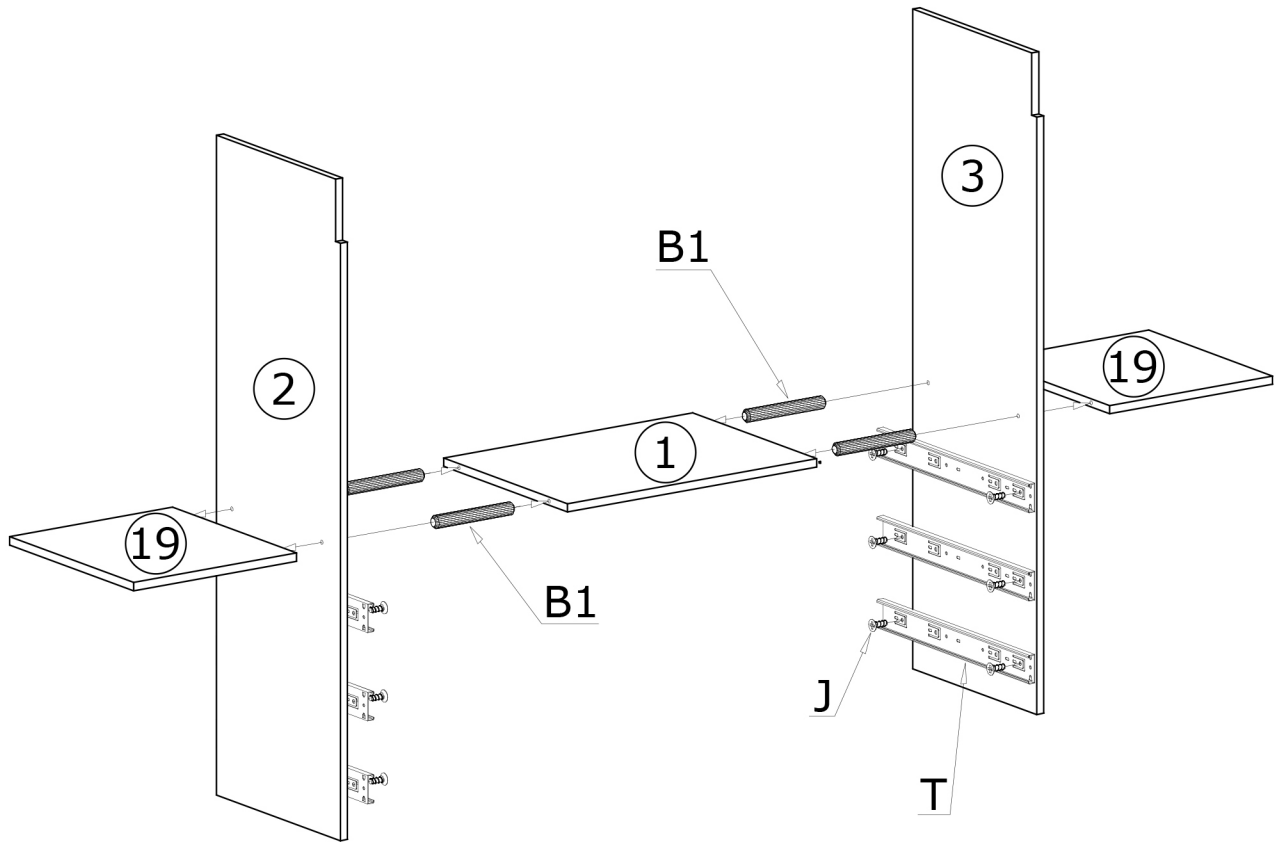

II

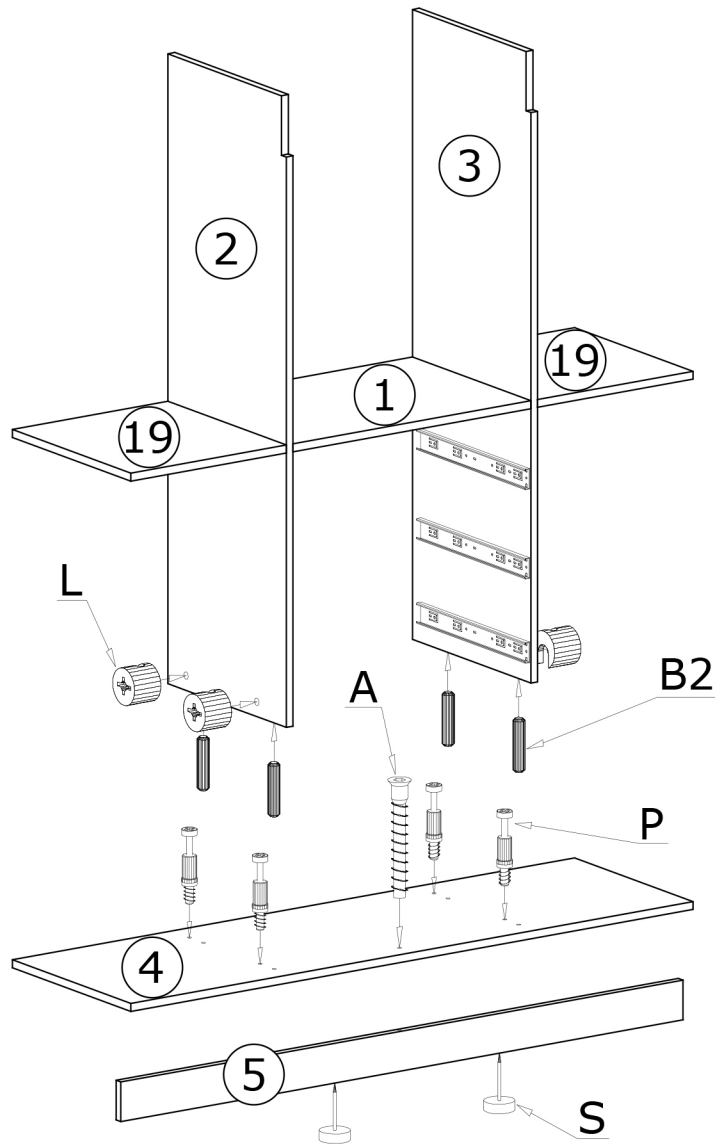

III

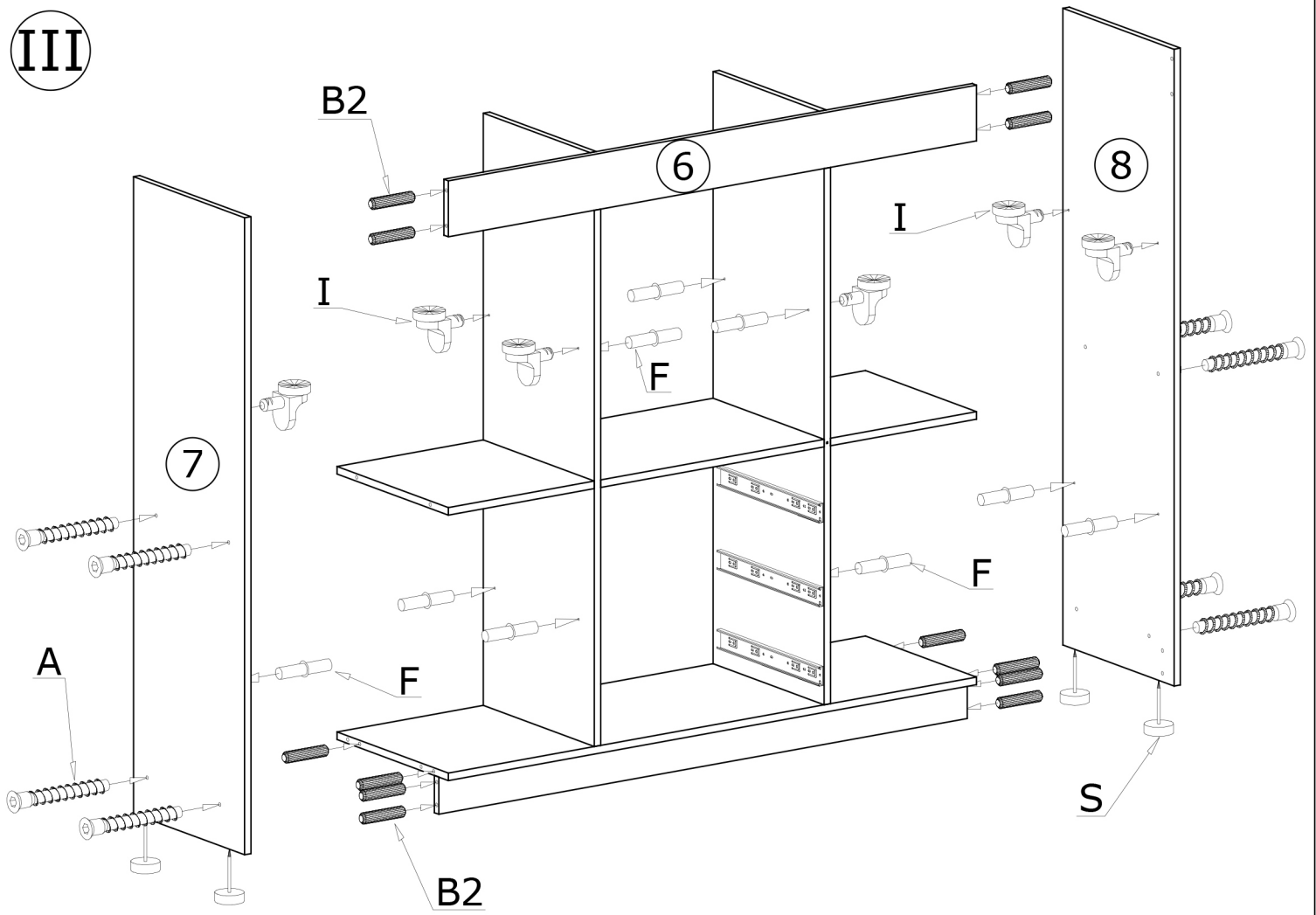

IV

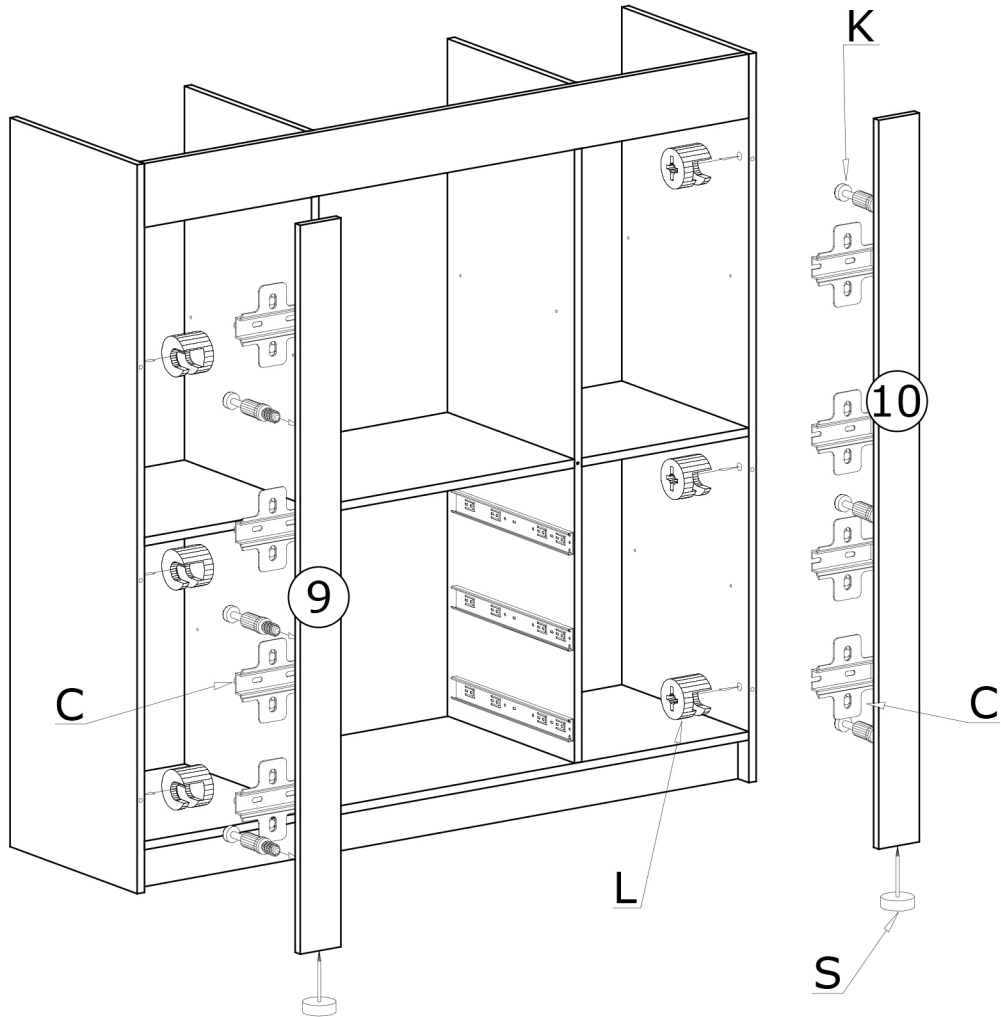

V

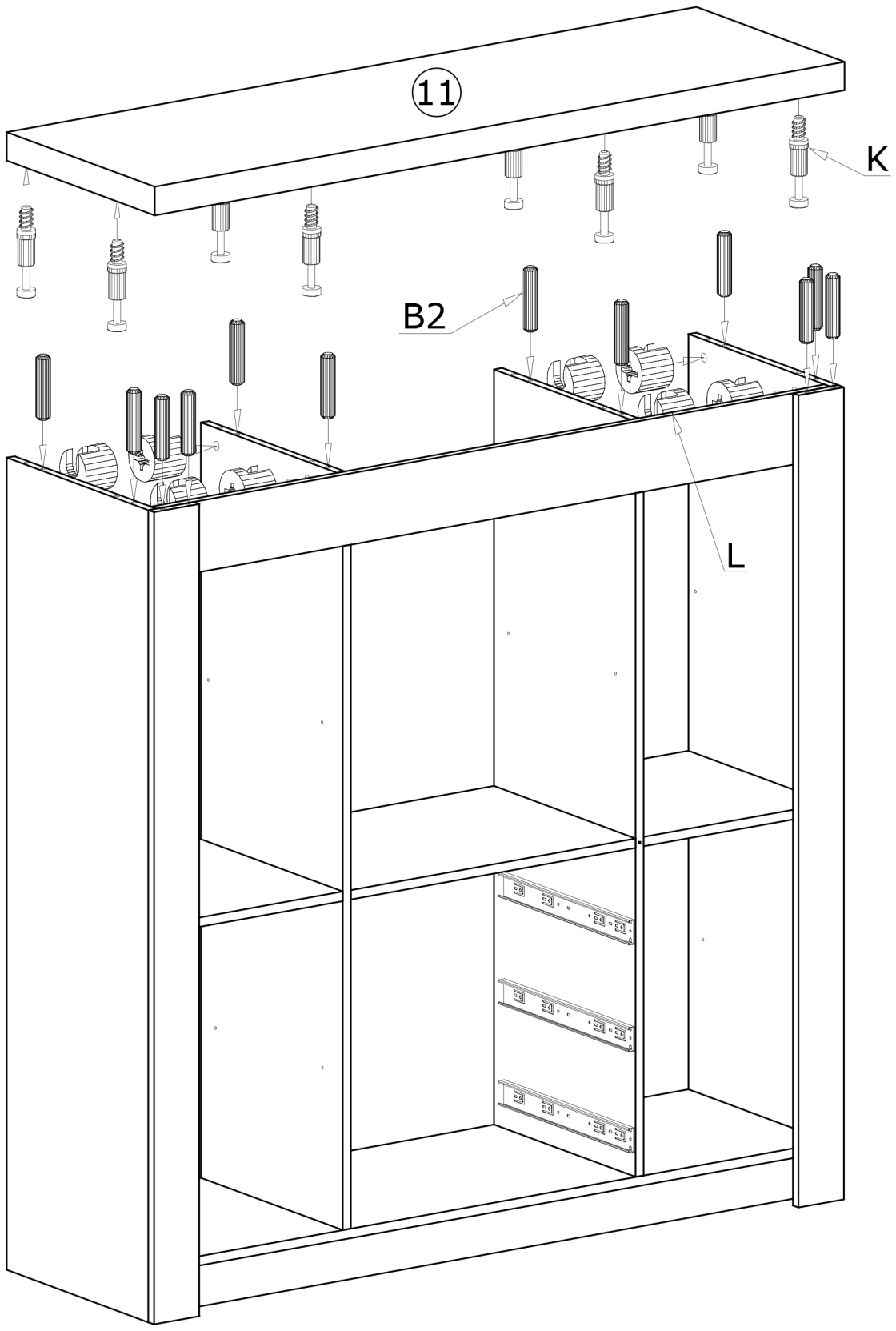

VI

80X 

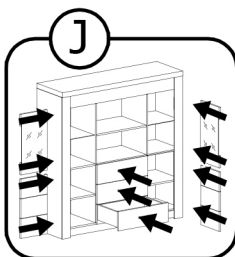
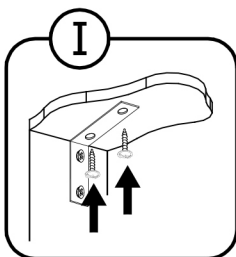
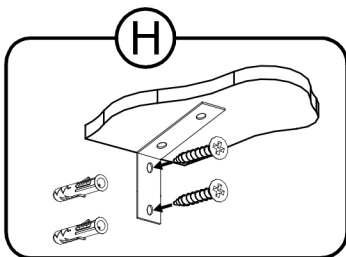
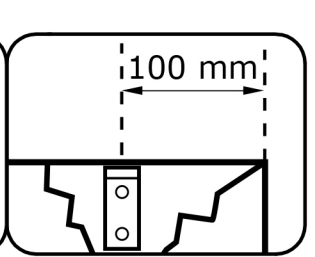
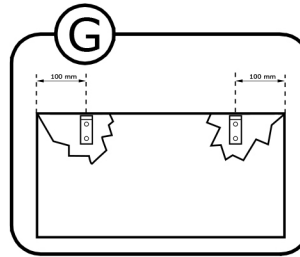
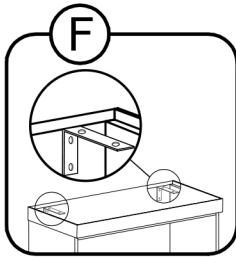
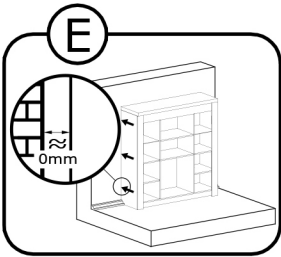
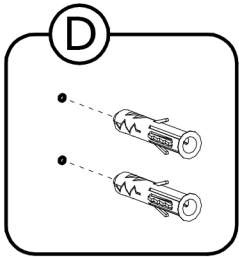
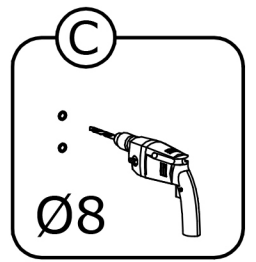
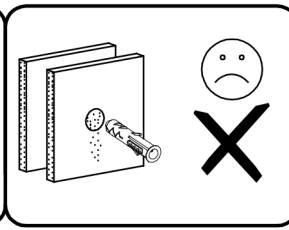
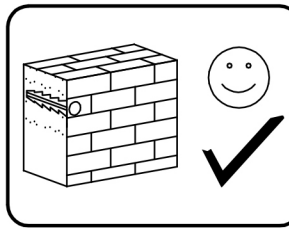
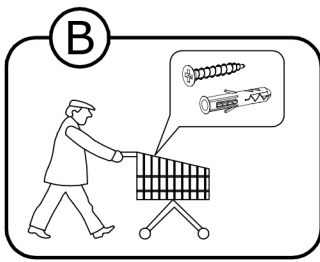
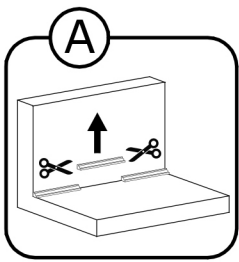
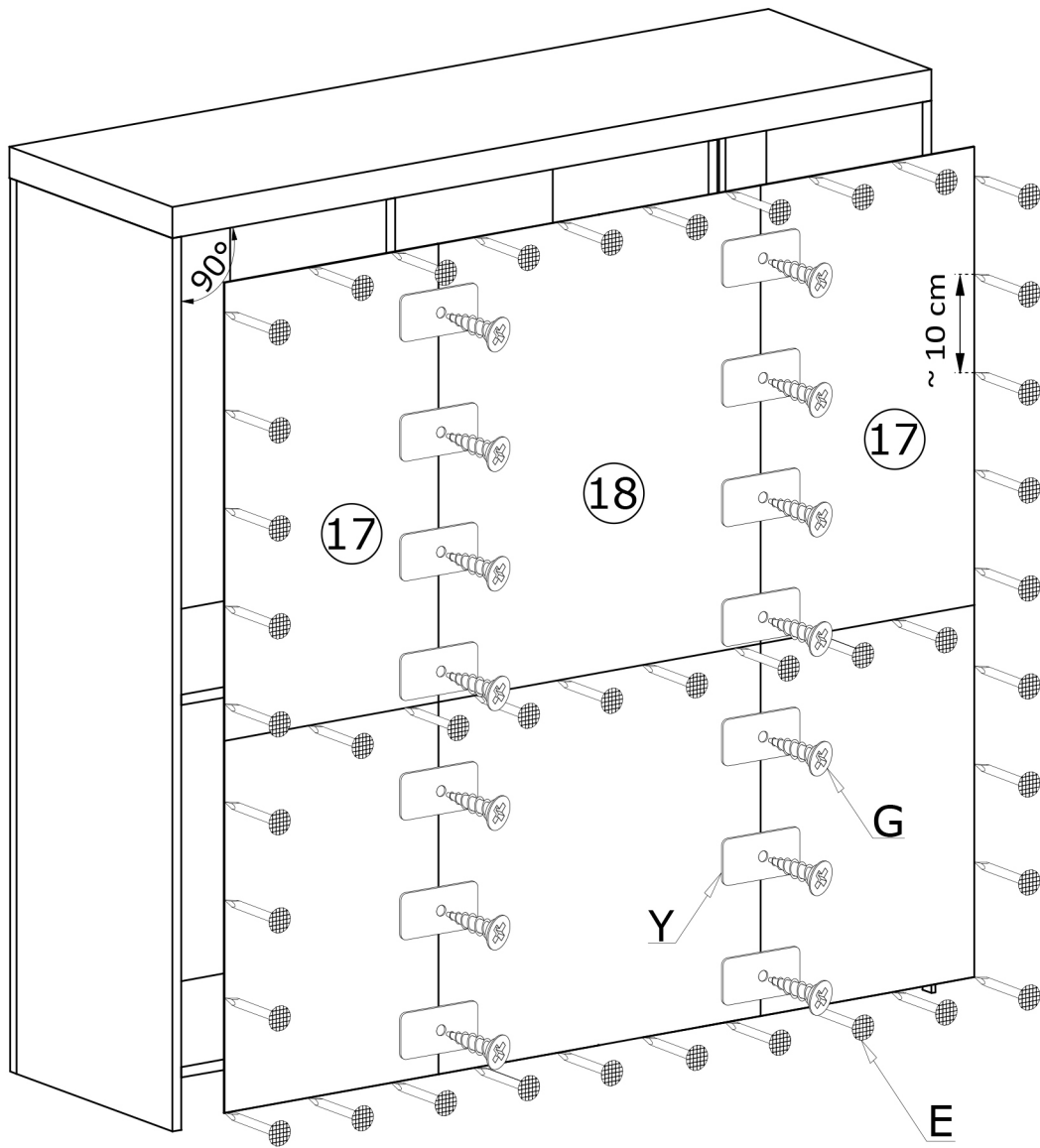

VII

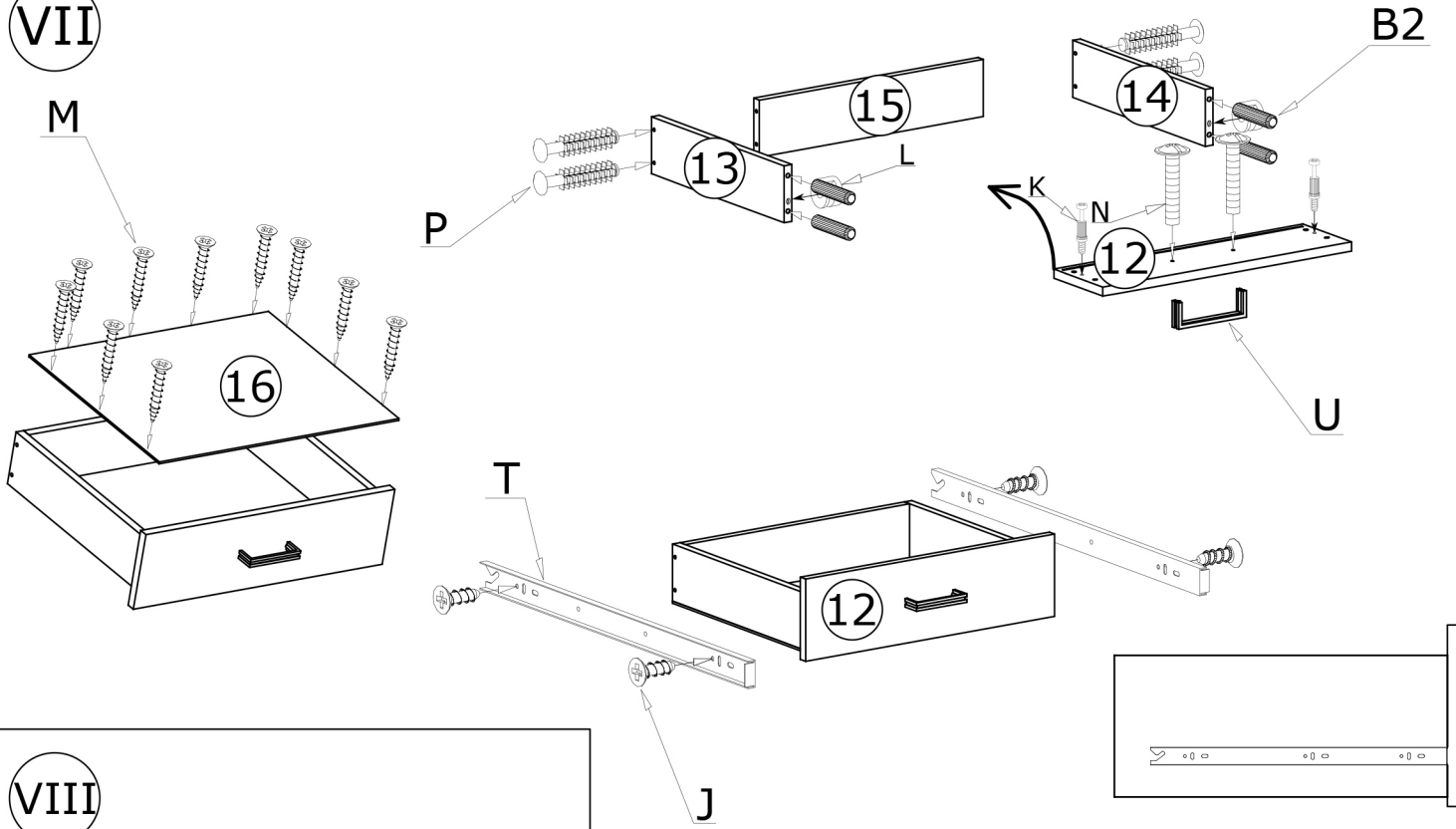

VIII

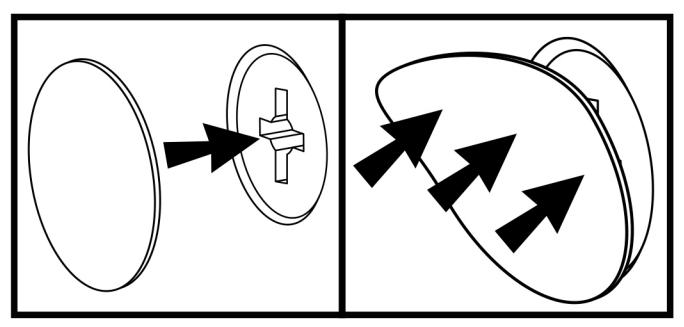
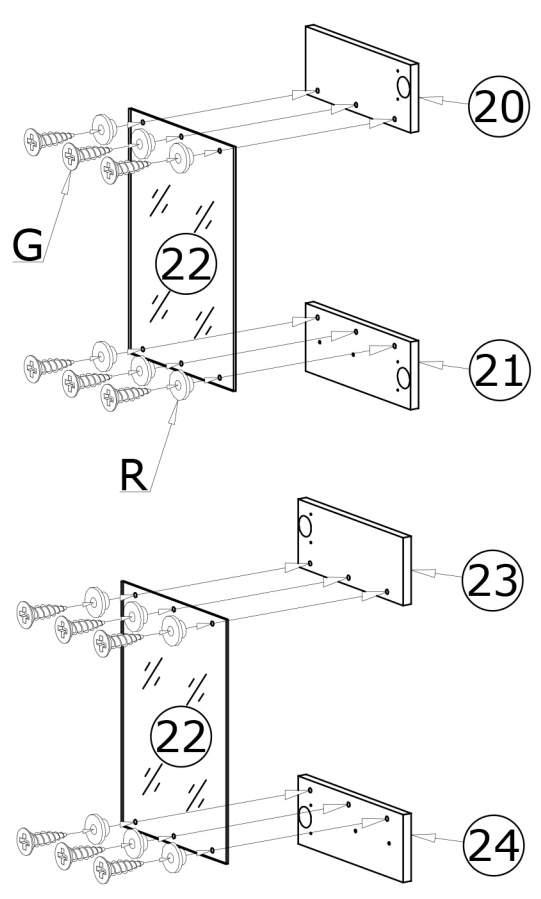

IX

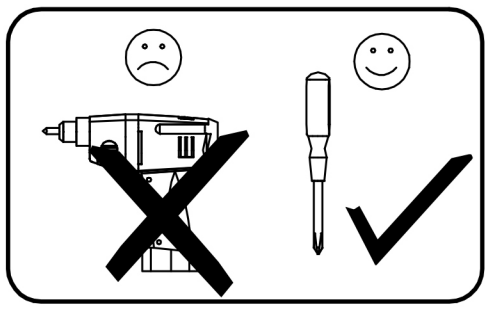
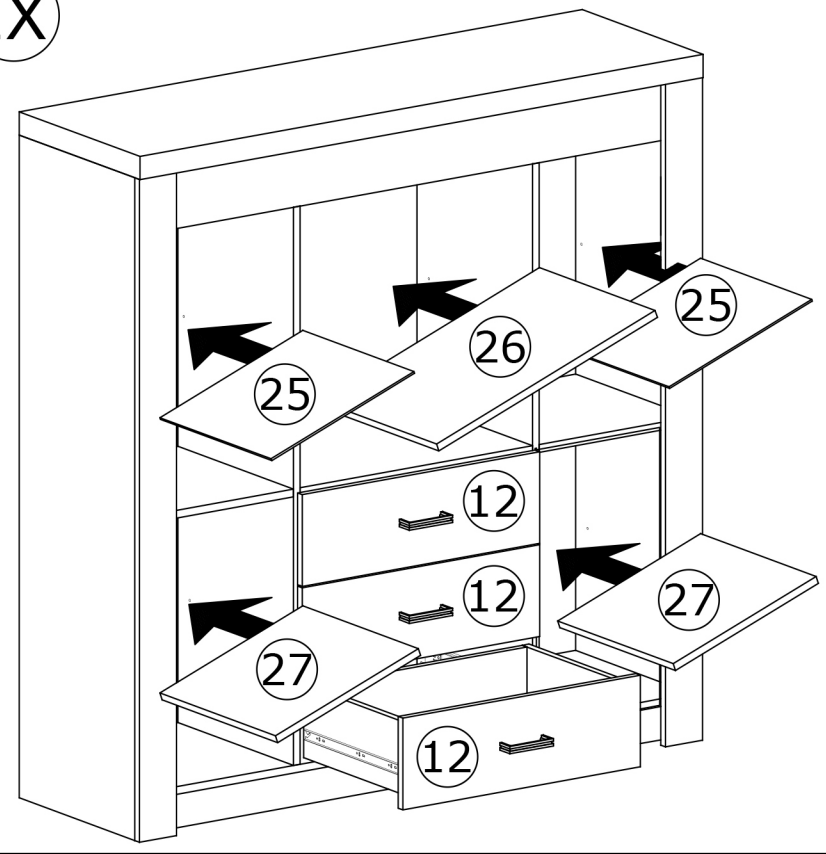

X

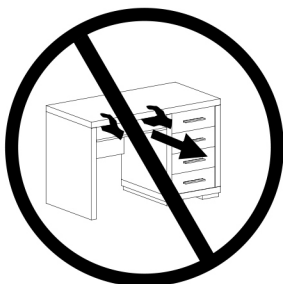
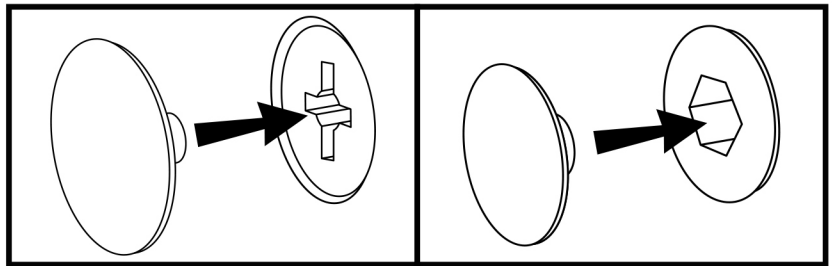
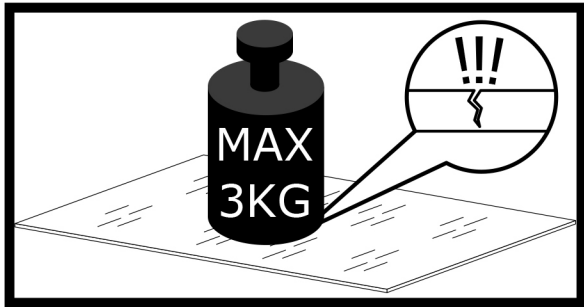
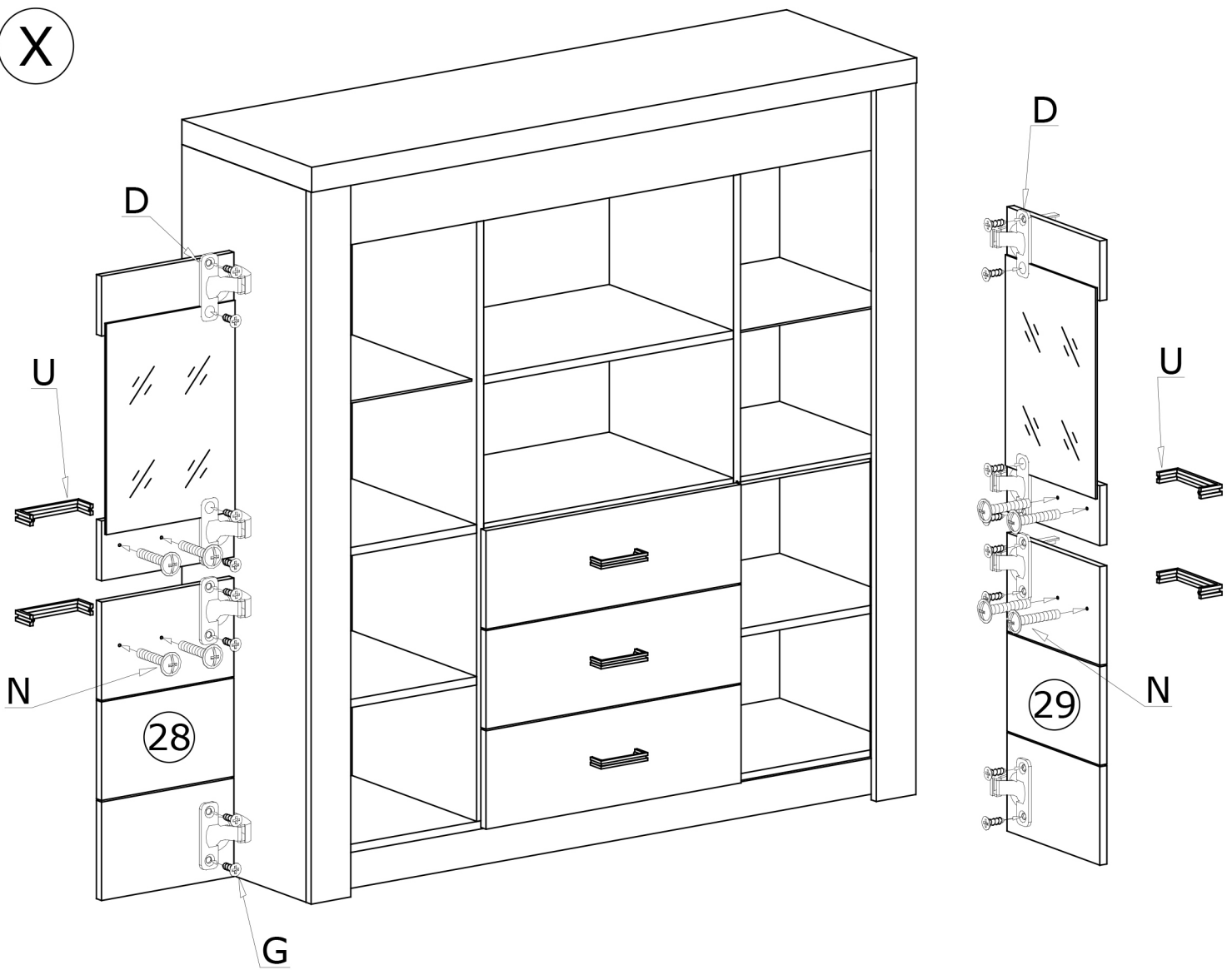

1

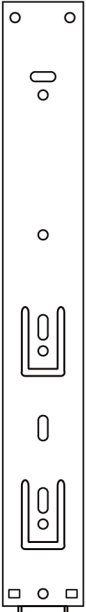

2

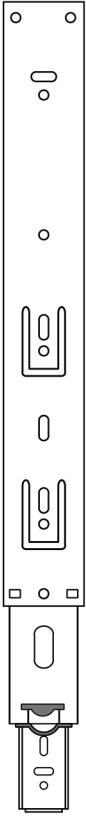

3

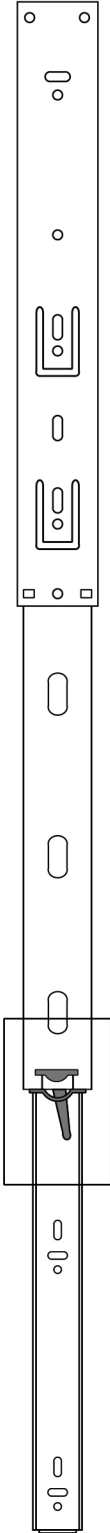

4



PL

UWAGA!!!

MONTOWANIE USZKODZONYCH ELEMENTÓW POWODUJE UTRATĘ GWARANCJI

UWAGA!!!

MEBEL ZAWIERA ELEMENTY DREWNIANE

W PRZYPADKU REKLAMACJI PROSZĘ PODAĆ NUMER PAKOWACZA ZNAJDUJĄCY SIĘ NA KARTONIE
ODCIĘŃ DREWNA I UKŁAD SŁOI MOGĄ NIEZNACZNIE ODBIEGAĆ
OD PREZENTOWANYCH NA ZDJĘCIACH KATALOGOWYCH

CZ

UPOZORNĚNÍ!!!

MONTÁŽ POŠKOZENÝCH KOMPONENTŮ RUŠÍ PLATNOU ZÁRUKU

UPOZORNĚNÍ!!!

NÁBYTEK OBSAHUJE DŘEVĚNÉ PRVKY

V PŘÍPADĚ REKLAMACE UVEĎTE PROSÍM ČÍSLO BALIČE, KTERÉ NAJDETE NA KRABICI
ODSTÍN A KRESBA DŘEVA SE MOHOU VÝRAZNĚ LIŠIT
OD TĚCH ZOBRAZENÝCH NA KATALOGOVÝCH FOTOGRAFIÍCH

DE

BEACHTUNG!!!

DER EINBAU BESCHÄDIGTER KOMPONENTEN SCHLIESST EINE GÜLTIGE GEWÄHRLEISTUNG AUS

BEACHTUNG!!!

MÖBEL ENTHALTEN HOLZELEMENTE

IM FALL EINER REKLAMATION GEBEN SIE BITTE DIE PAKETNUMMER AN,
DIE SIE AUF DEM KARTON FINDEN
HOLZSCHATTIERUNG UND HOLZZEICHNUNG KÖNNEN UNTERSCHIEDLICH
VON DEN AUF DEN KATALOGFOTOS GEZEIGTEN ABWEICHEN

HR

PAŽNJA!!!

INSTALACIJA OŠTEĆENIH KOMPONENTI ZA POSLJEDICU IMA GUBITAK JAMSTVA

PAŽNJA!!!

NAMJEŠTAJ SADRŽI DRVENE ELEMENT

U SLUČAJU REKLAMACIJE, MOLIMO NAVESTI BROJ PAKIRANJA KOJI SE NALAZI NA KUTIJI
NIJANSA DRVETA I RASPORED GODOVA MOGU MINIMALNO
ODUDARATI OD ONIH NA KATALOŠKIM FOTOGRAFIJAMA

HU

FIGYELEM!!!

SÉRÜLT ALKATRÉSZEK BEÉPÍTÉSE ESETÉN A GARANCIA ÉRVÉNYÉT VESZTI

FIGYELEM!!!

A BÚTOROK FA ELEMÉKET TARTALMAZNAK

REKLAMÁCIÓ ESETÉN KÉRJÜK, ADJA MEG A DOBOZON TALÁLHATÓ CSOMAGOLÁSI SZÁMOT
A FA ÁRNYALATA ÉS A CSOMÓK ELRENDEZÉSE
JELENTŐSEN ELTÉRHET A KATALÓGUSBAN SZEREPLŐ KÉPEKTŐL

SK

UPOZORNENIE!!!

INŠTALÁCIOU POŠKODENÝCH KOMPONENTOV SA RUŠÍ ZÁRUKA

UPOZORNENIE!!!

NÁBYTOK OBSAHUJE DREVENÉ PRVKY

V PRÍPADE REKLAMÁCIÍ UVEĎTE ČÍSLO BALENIA NÁJDENÉ NA KRABICI
ODTIEŇ DŘEVA A USPORIADANIE UZLOV
SA MÔŽE VÝRAZNĚ LIŠIŤ OD KATALÓGOVÝCH OBRÁZKOV

SR

PAŽNJA!!!

MONTAŽA OŠTEĆENIH DELOVA DOVODI DO GUBITKA GARANCIJE

PAŽNJA!!!

NAMEŠTAJ SADRŽI DRVENE DELOVE

U SLUČAJU REKLAMACIJA MOLIMO DA DOSTAVITE PAKER BROJ KOJI SE NALAZI NA KARTONU
NIJANSA BOJE DRVETA I RASPORED SLOJEVA MOGU NEZNATNO
DA SE RAZLIKUJU OD PREZENTOVANIH NA SLIKAMA U KATALOGU