

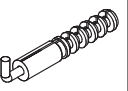



30 min

KR2 X3		D20 X6	 ESØ6x9,5	B11 X6	 Ø7x50	G4 X6		G2 X1		ZM1 X3	
A1 X6	 Ø8x36										



1

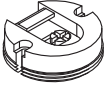
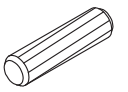
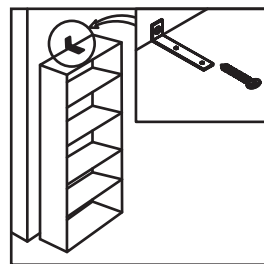
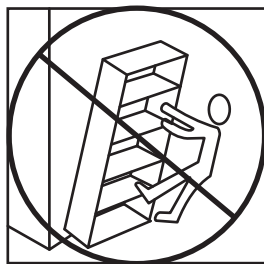
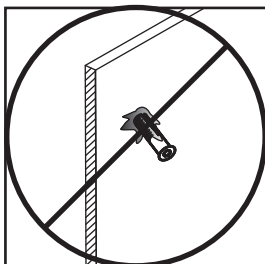
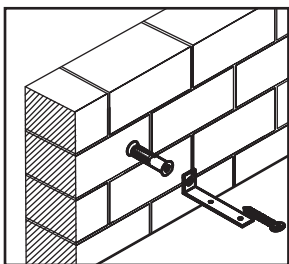
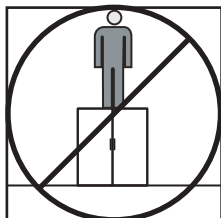
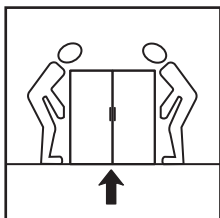
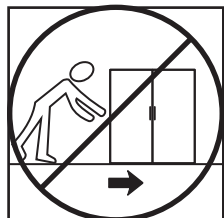
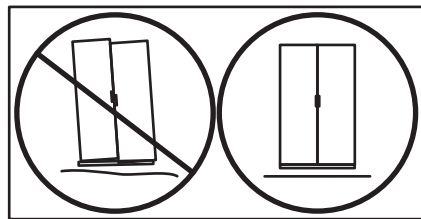
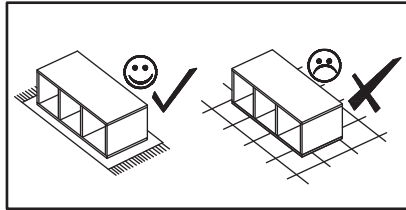
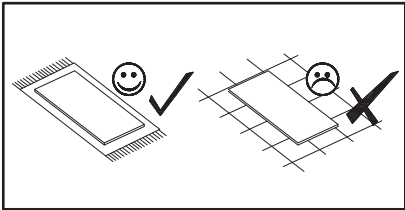
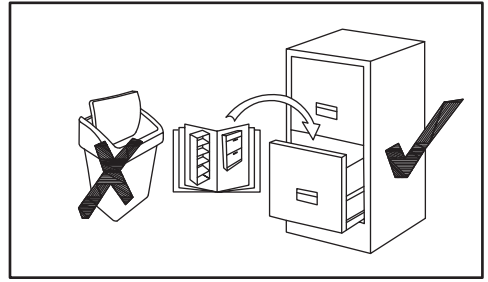
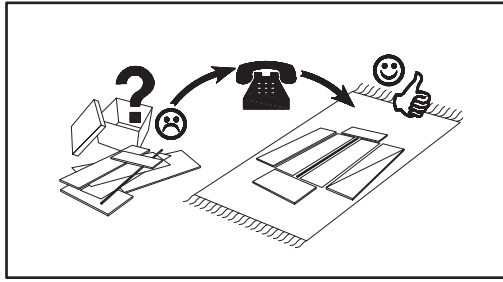
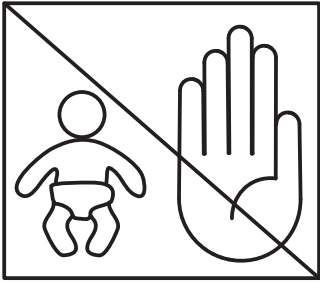
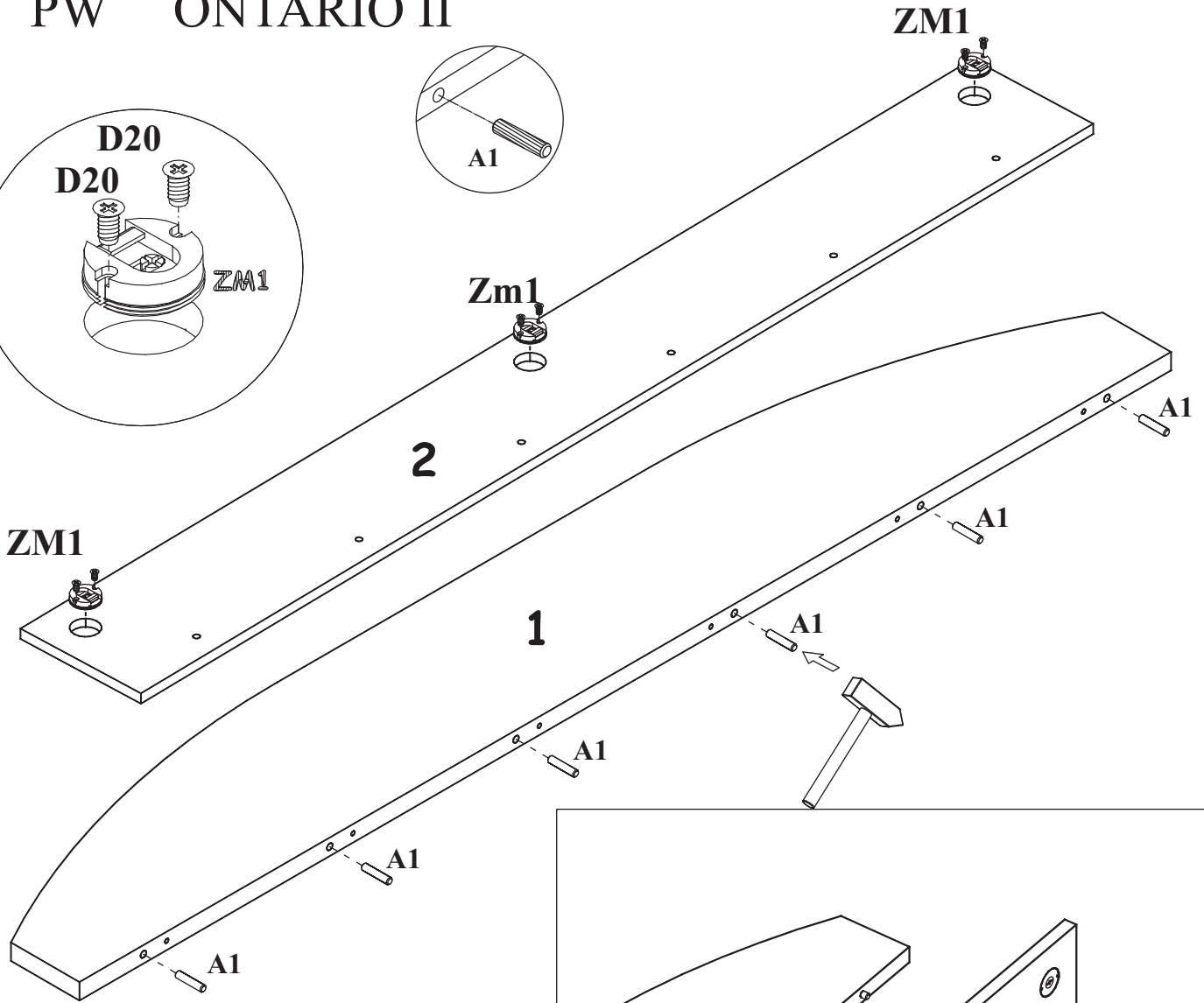
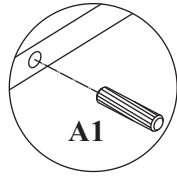
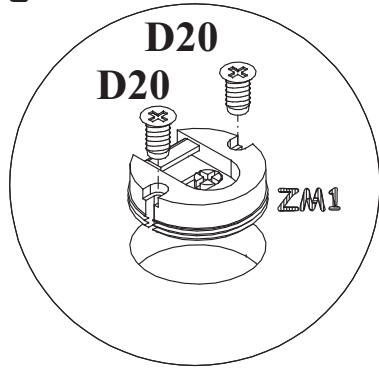

2

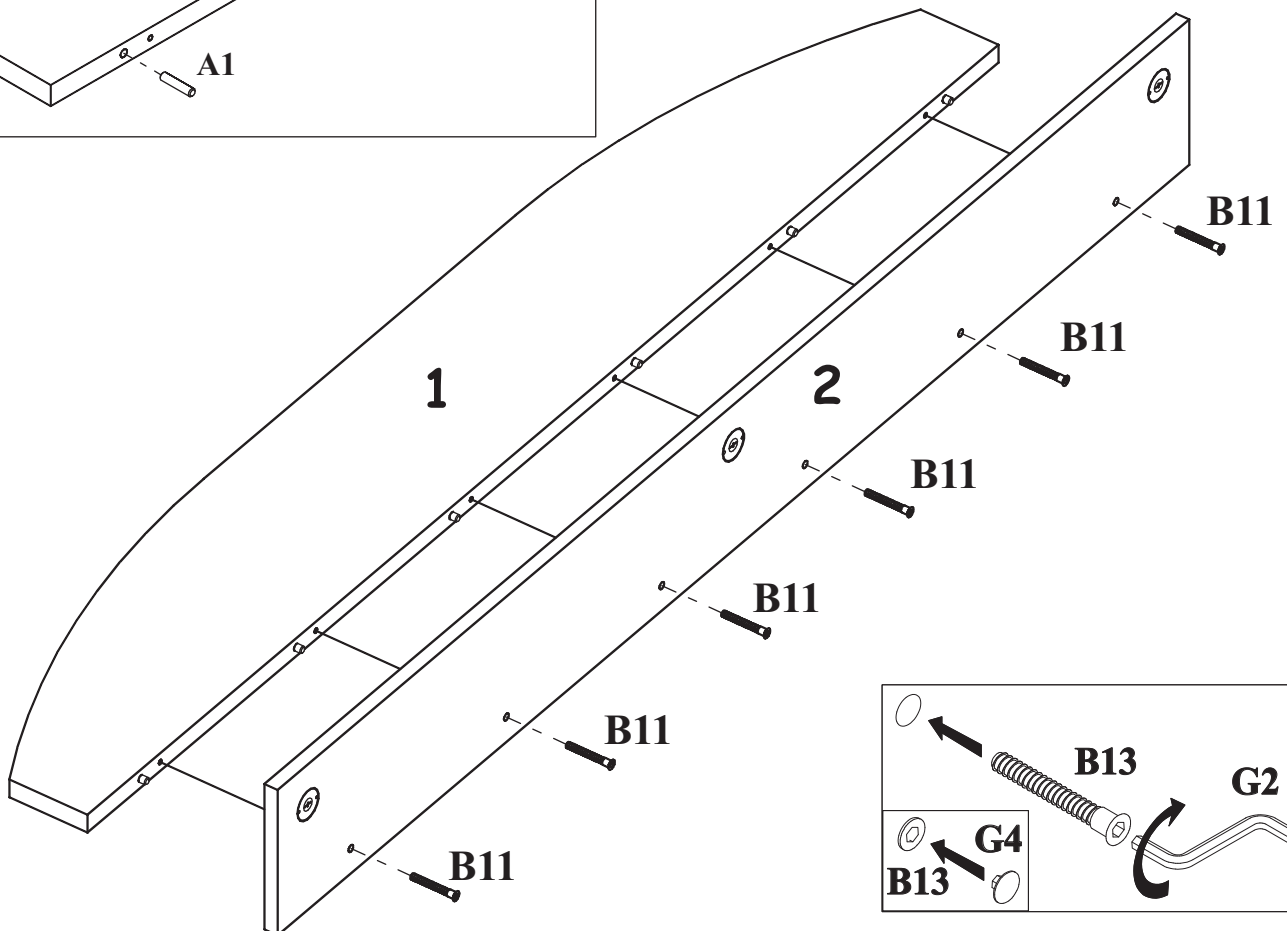

3

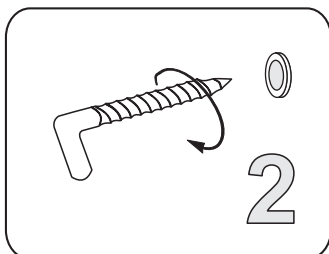
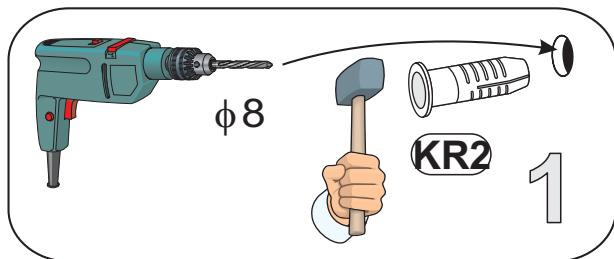
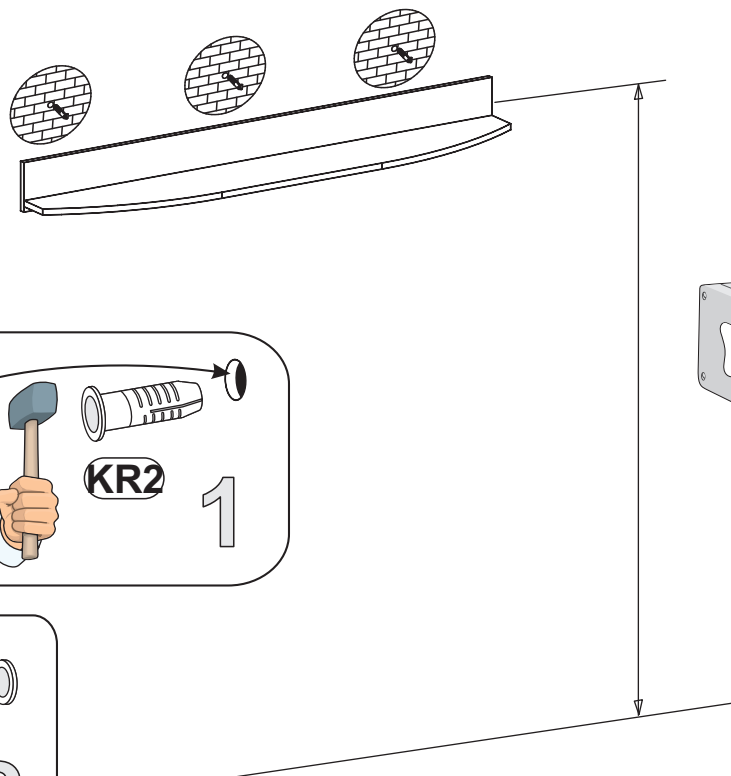

4

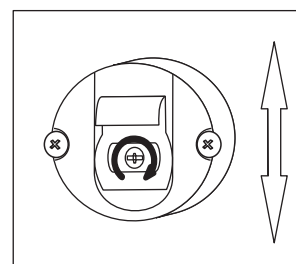
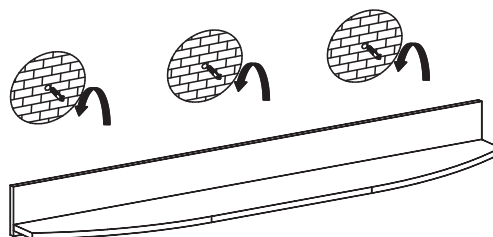
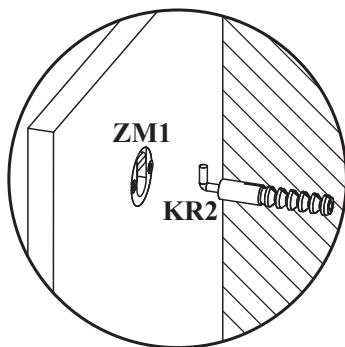

ZM1