

EDGE 29 -- EE WSW

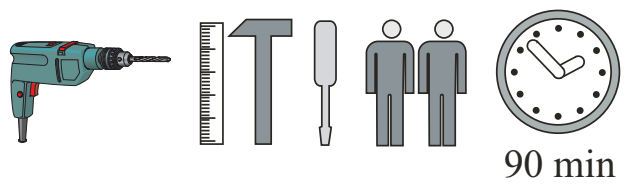

NO	Dim.			Col.-No	Qty
1	1890	384	16	2	1
2	1890	334	16	2	1
3	668	384	16	1	1
4	702	384	16	1	1
5	1874	364	16	2	1
6	1865	300	4	3	1
7	305	279	4	1	1
8	668	80	16	2	1
9	314	349	6	1	4
10	326	354	16	1	4
11	346	1900	16	3	1
12	296	1900	16	3	1
13	1865	280	4	3	1
14A	1885	341	3	3	1
14B	1885	341	3	3	1

EDGE 29 -- EE WSW

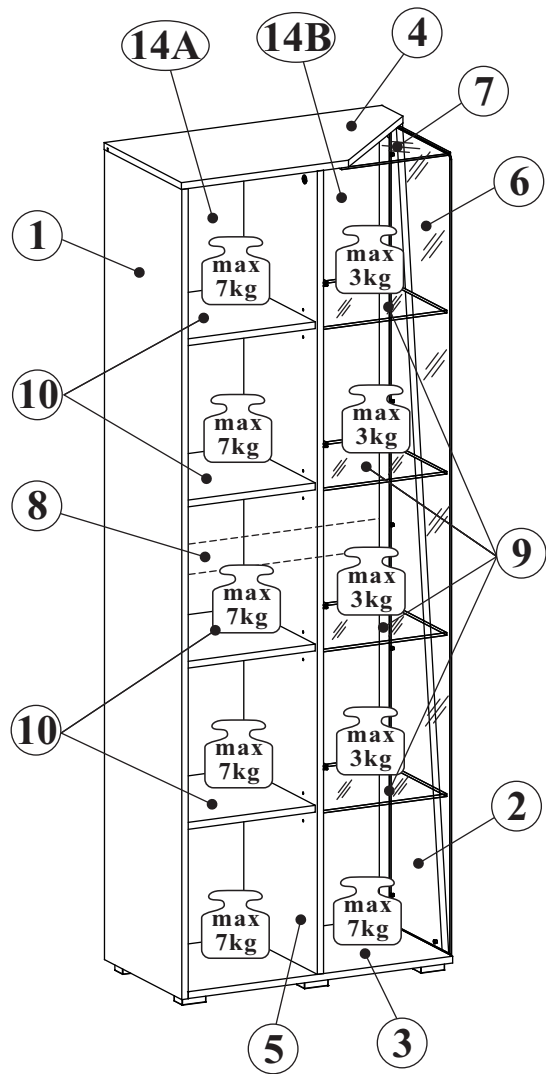
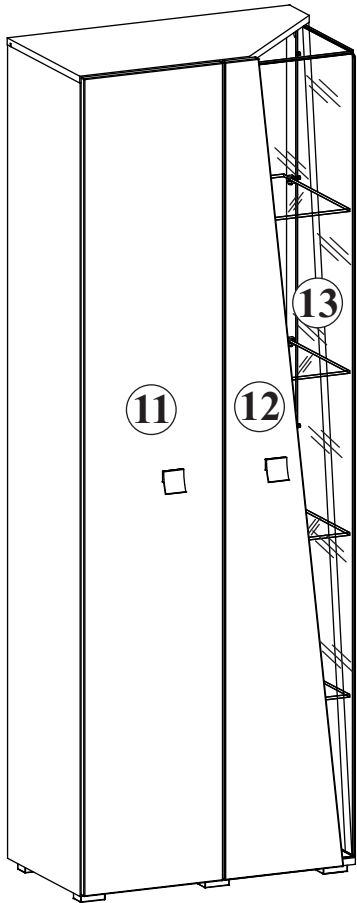
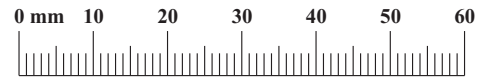



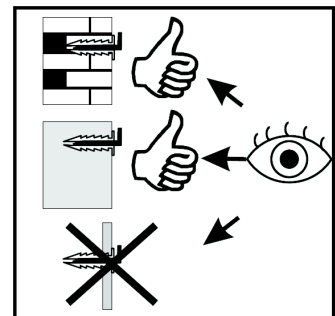
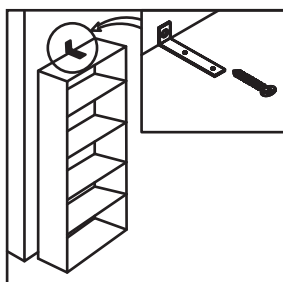
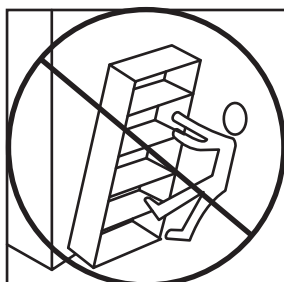
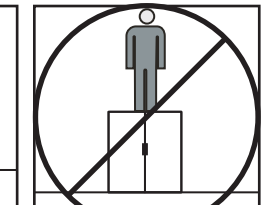
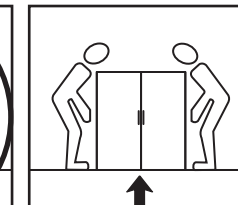
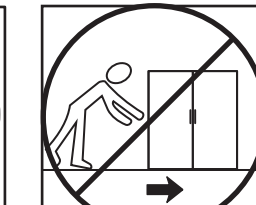
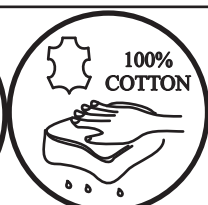
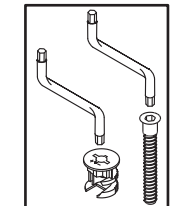
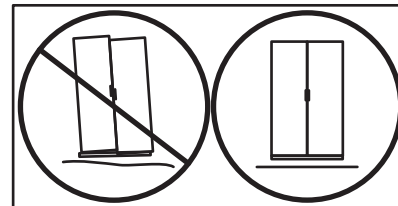
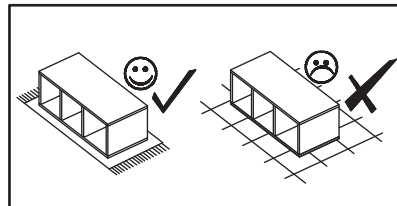
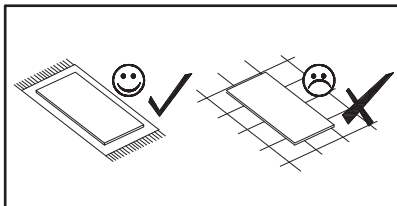
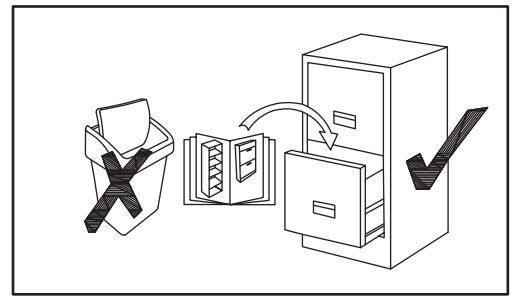
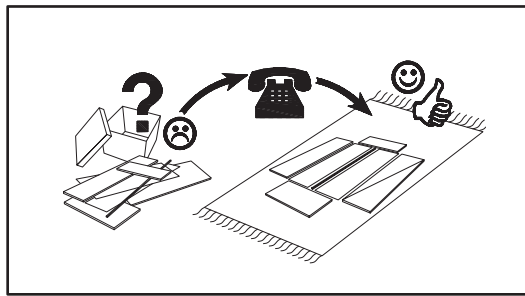
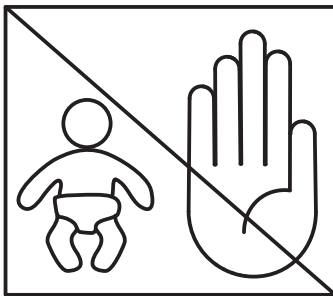

A1 x13 ø8x36	B4 x11	B5 x11 ø15x12	G5 x11	B11 x2 ø7x50	G4 x2
E21 x4 Ø35 H=0	E23 x4 Ø35 H=8	E2 x8 H=0	D10 x18 USØ3,5x13	G7 x16	G31 x12
ST17 x6	UP11 x12 UPØ4x20	G16 x12	UP13 x34 UPØ3x16	P2 x22	D20 x12 ESØ6,3x9,5
U19 x2	DS4 x4 WSM4x22	S1 x18	LED x1 x4	KR1 x1	L1 x1
G2 x1					

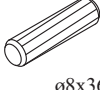

EDGE 29 -- EE WSW

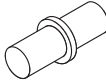
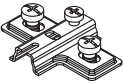
3

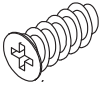
A1 x4	 ø8x36	B5 x2	 ø15x12	G7 x8		E2 x4	 H=0
G31 x8		D20 x8	 ES06,3x9,5				

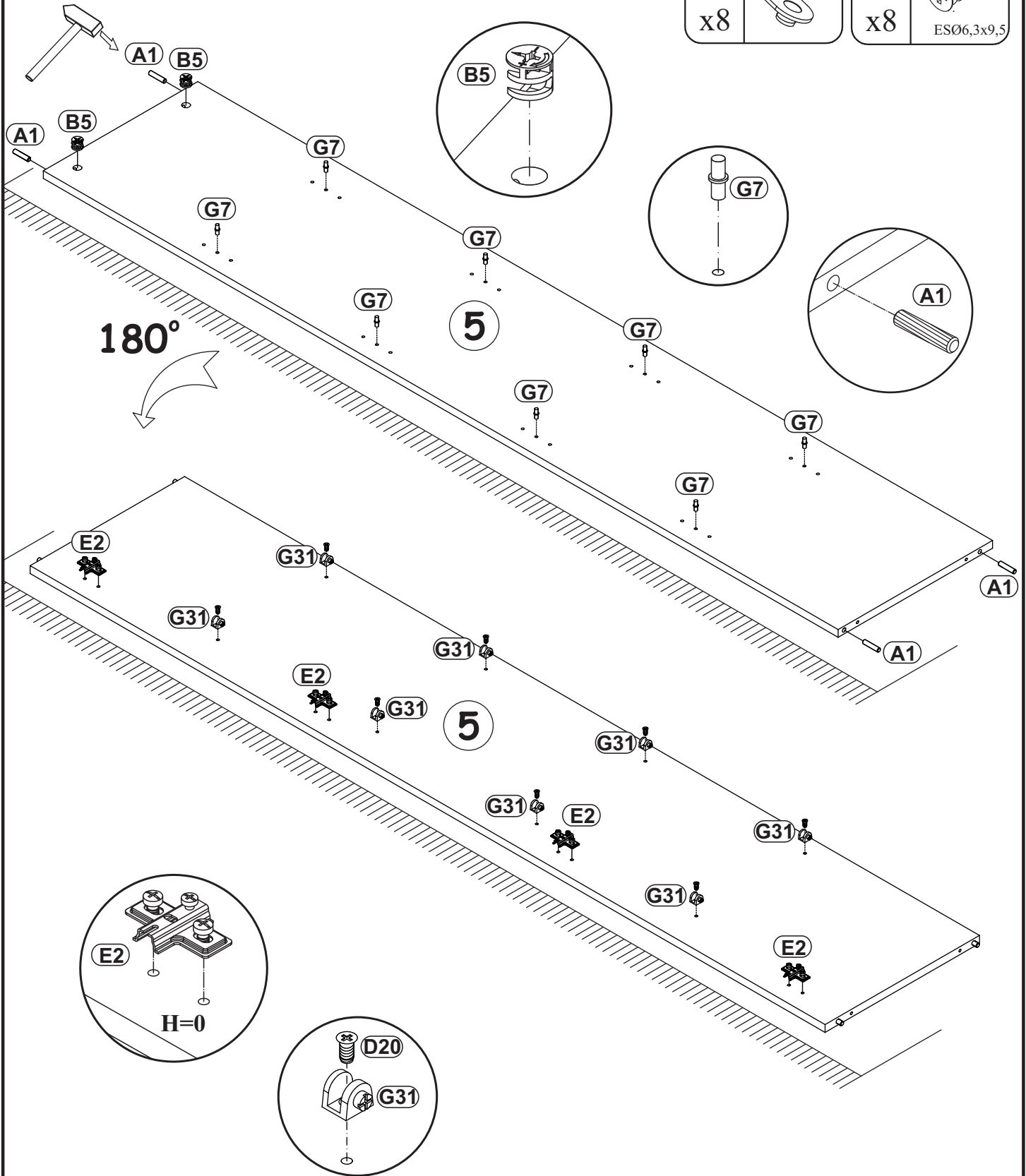

EDGE 29 -- EE WSW

4

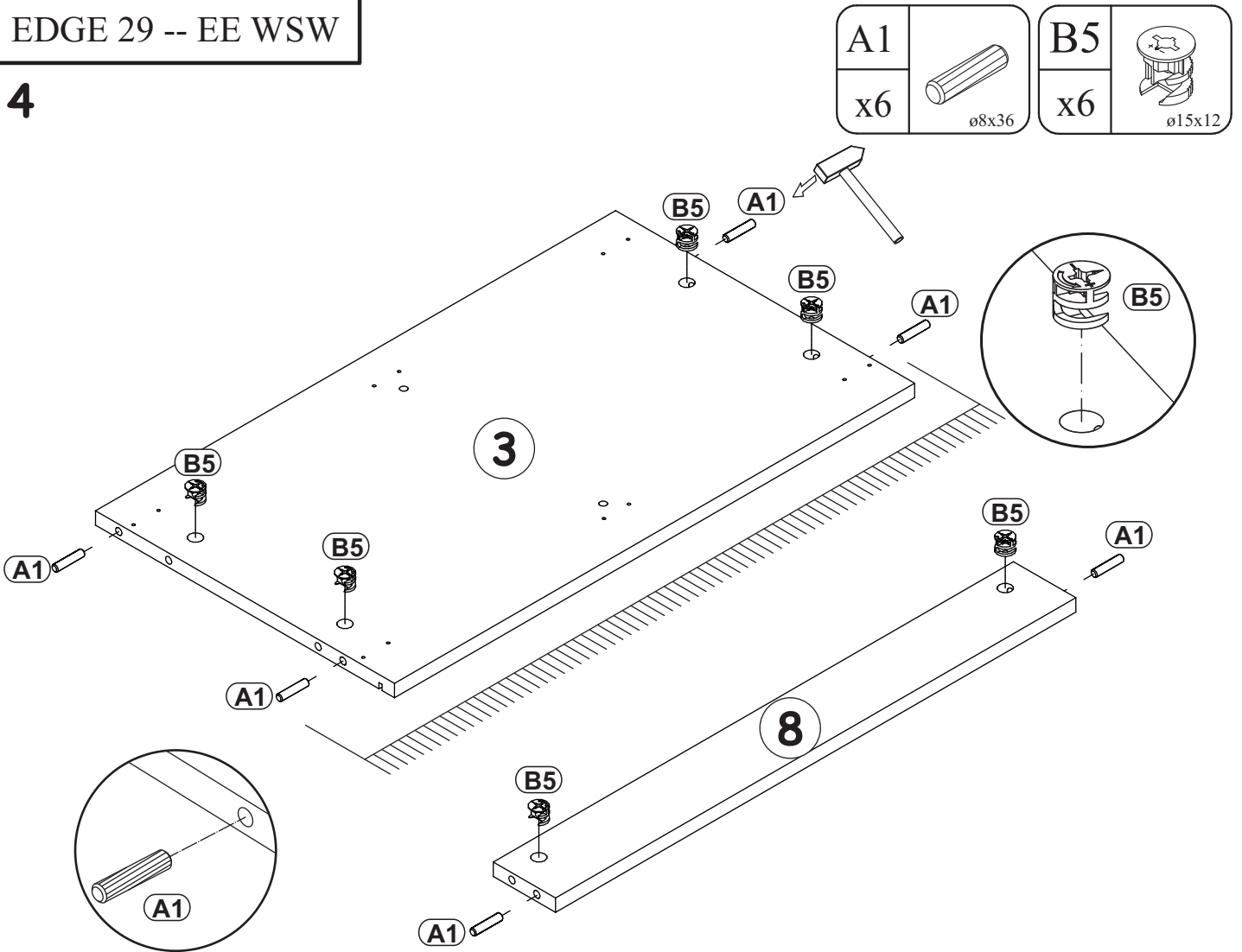

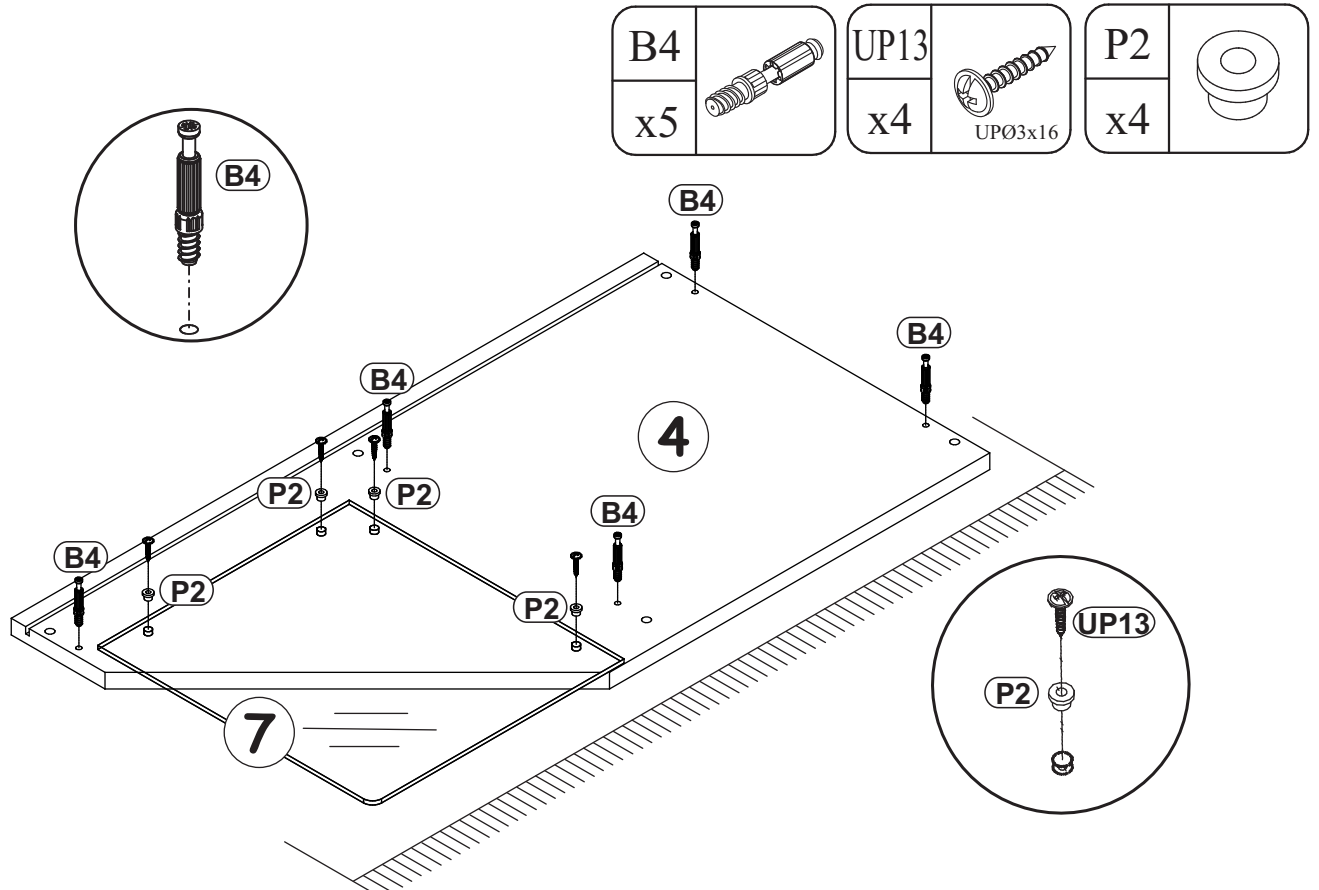

5



EDGE 29 -- EE WSW

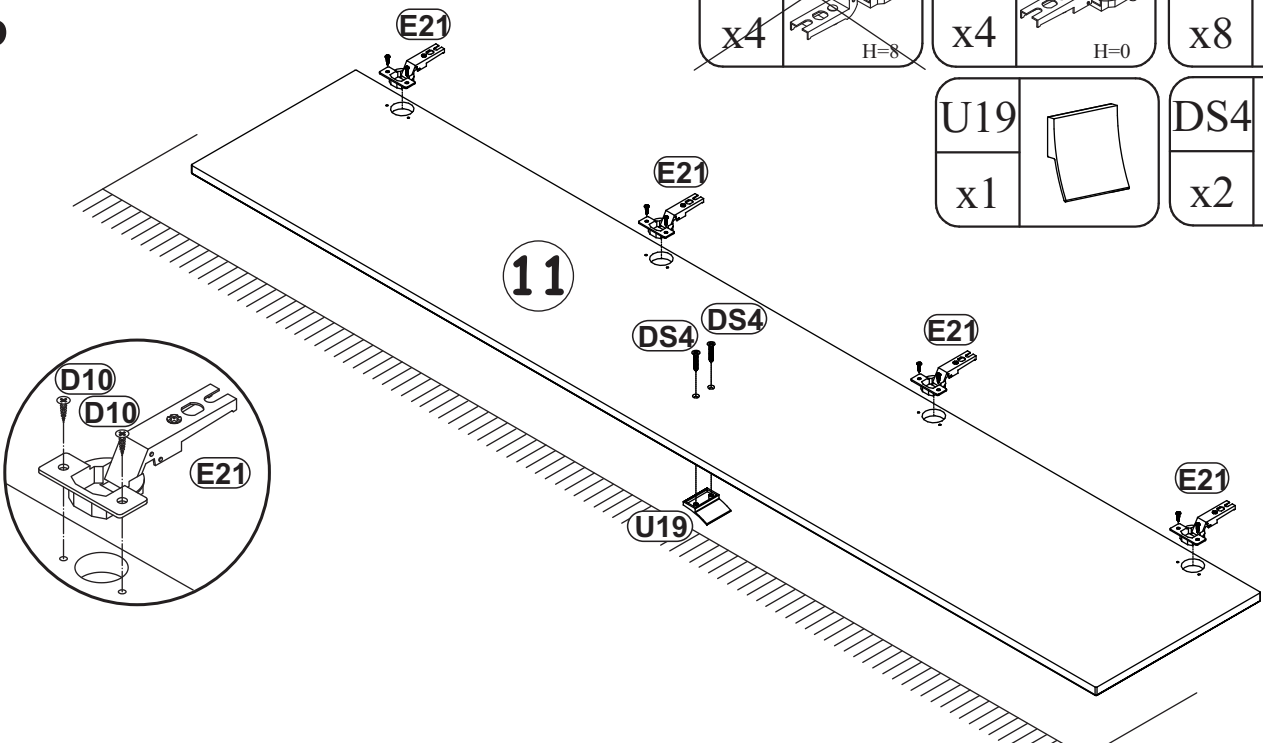

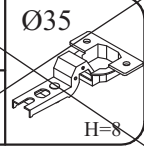
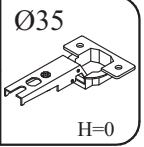
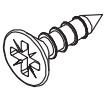
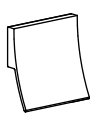

6

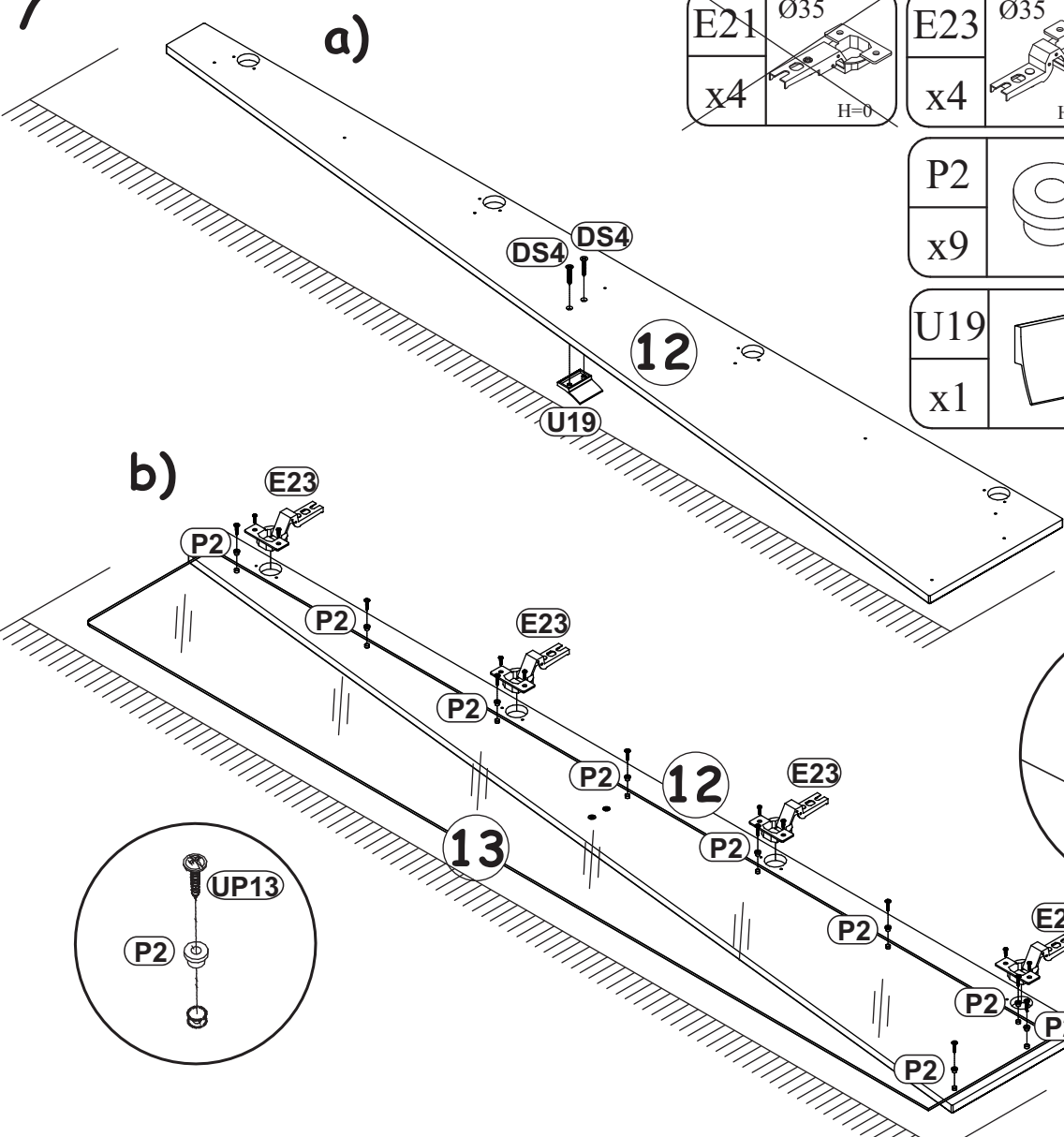

E23 x4	 Ø35 H=8	E21 x4	 Ø35 H=0	D10 x8	 USØ3,5x13
U19 x1		DS4 x2	 WSM4x22		

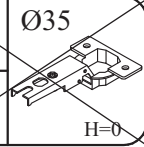
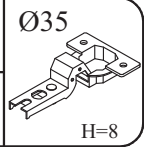
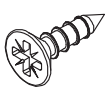
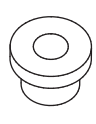
7

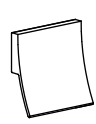



E21 x4	 Ø35 H=0	E23 x4	 Ø35 H=8	D10 x8	 USØ3,5x13
P2 x9		UP13 x9	 UPØ3x16		
U19 x1		DS4 x2	 WSM4x22		

G5	
x6	

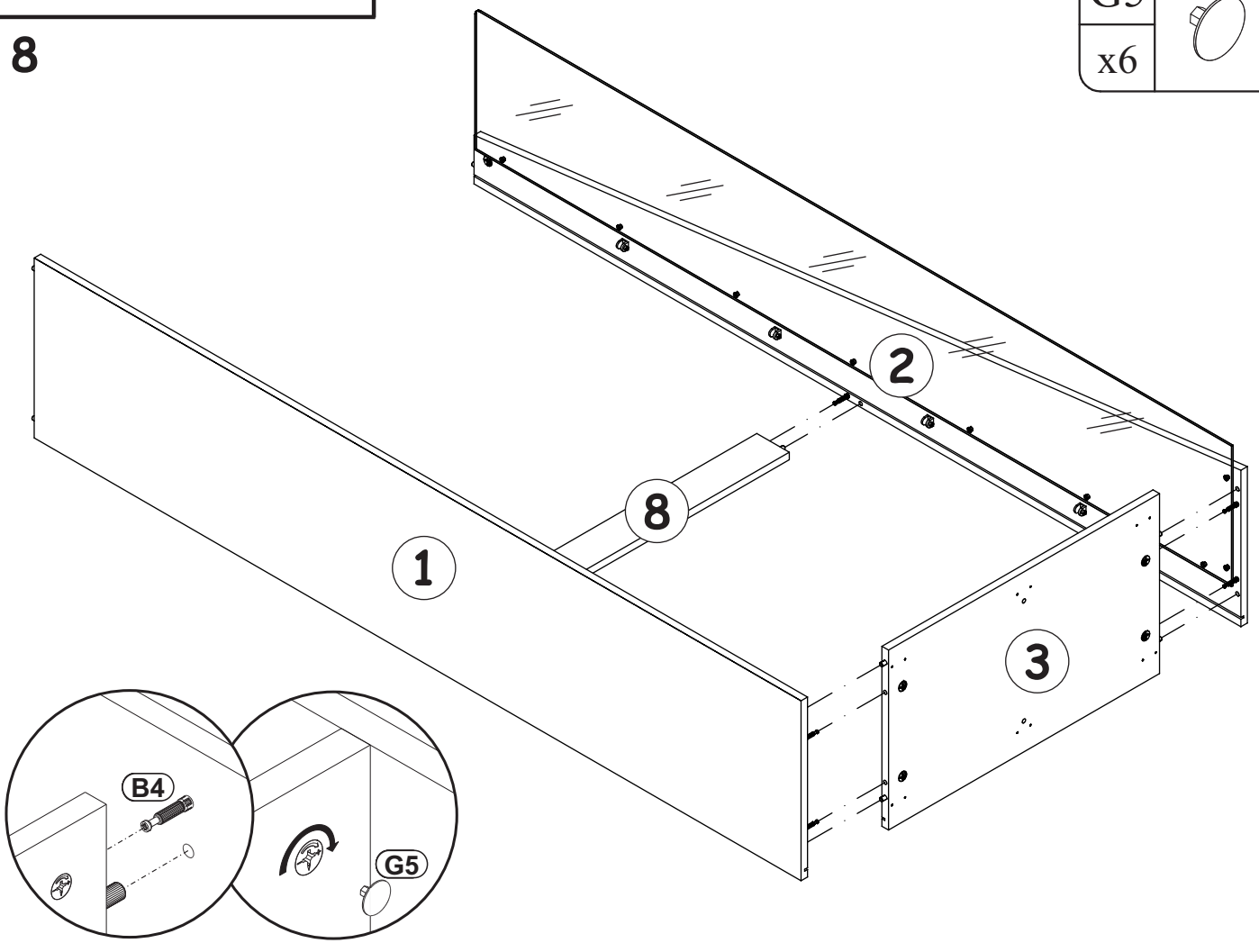
8



9

B11		G4	
x2	Ø7x50	x2	

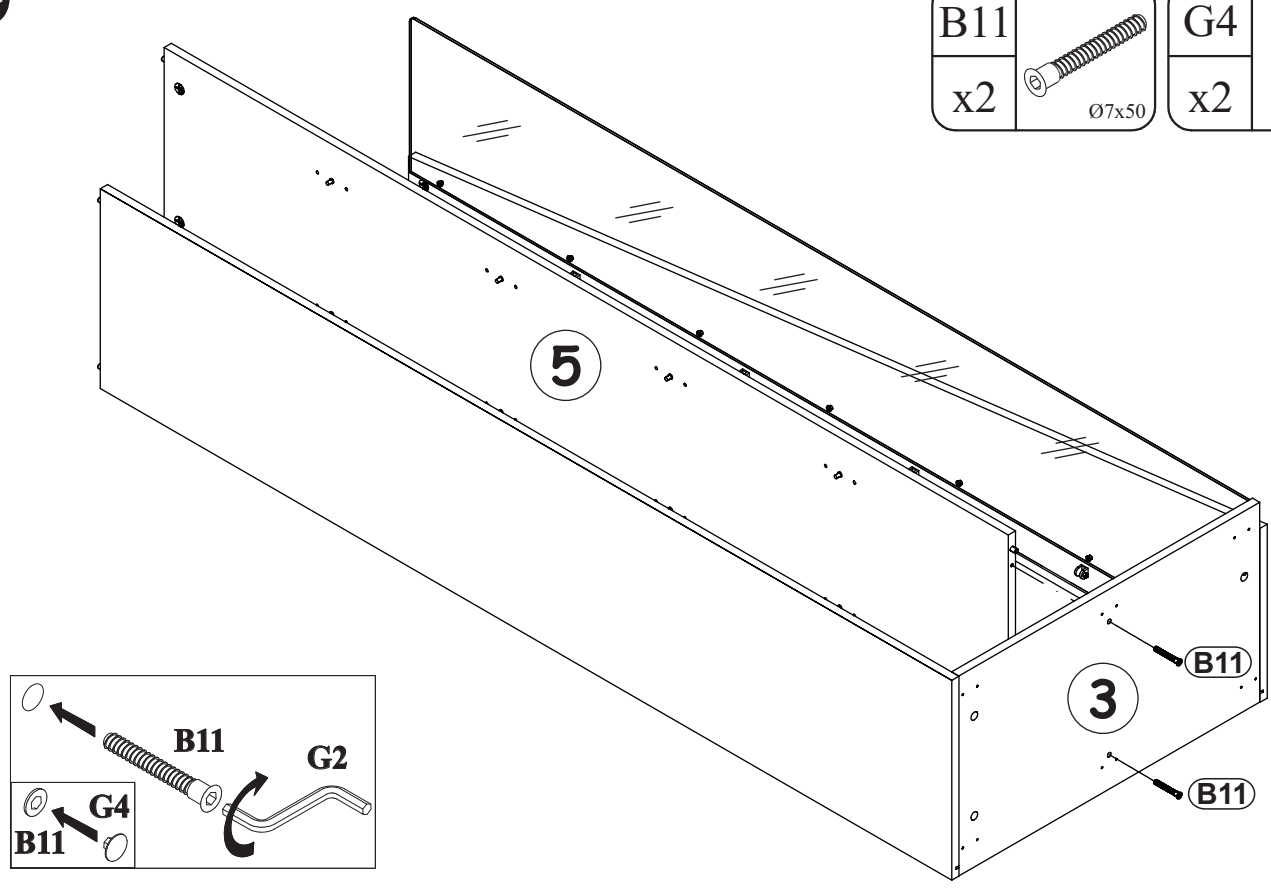

10

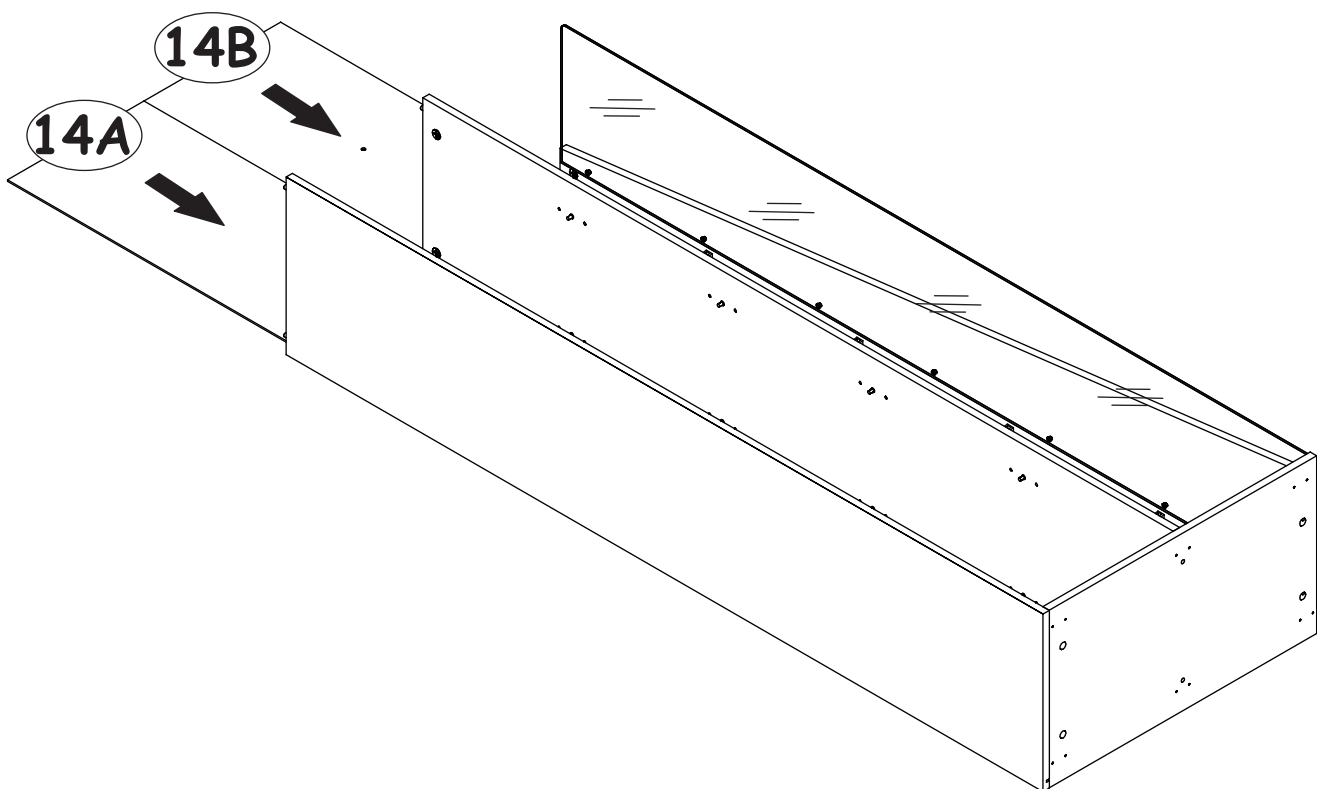

11

G5	
x5	

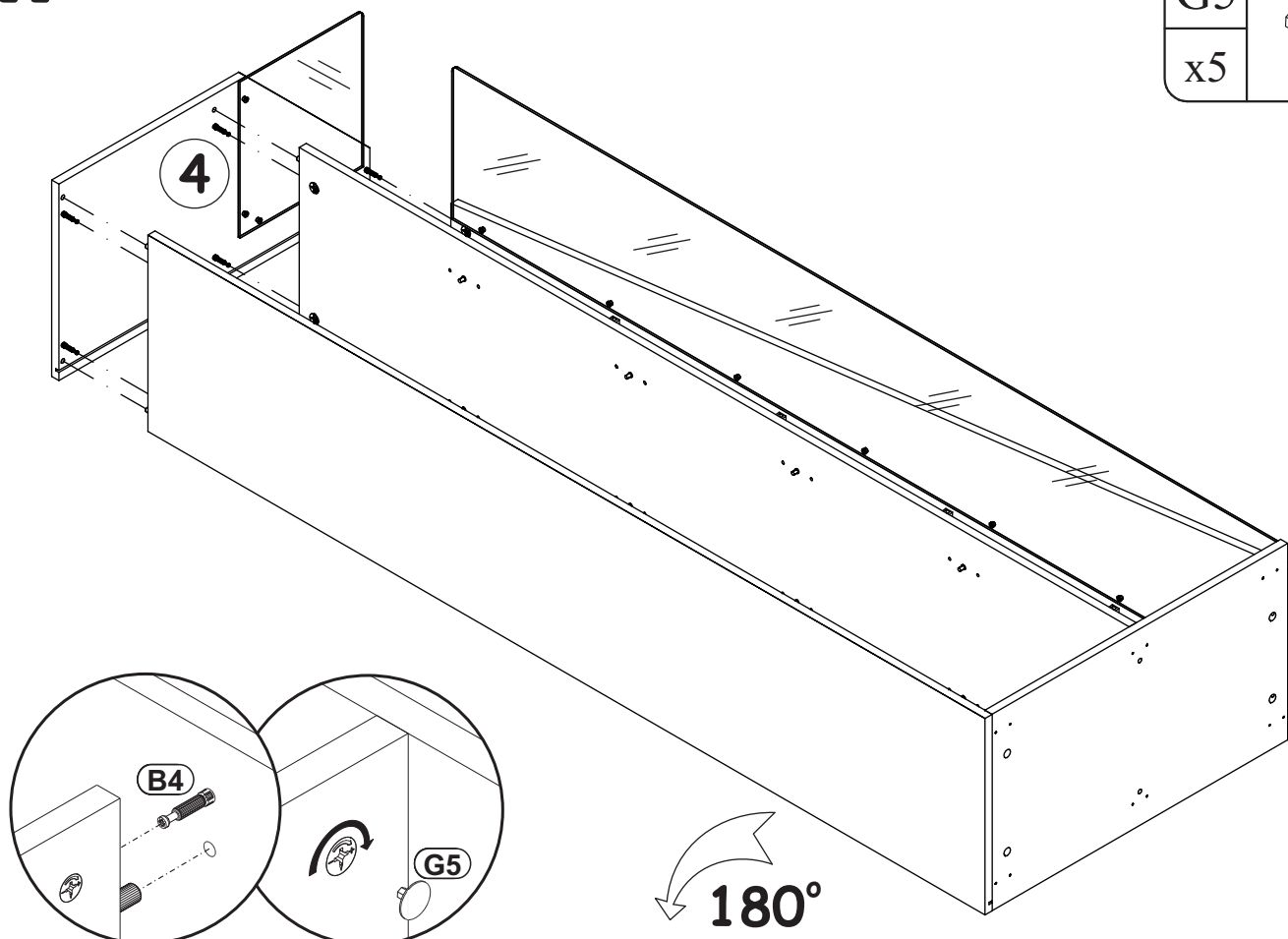

EDGE 29 -- EE WSW

12

S1		G16		UP13		ST17	
x18		x12		x12	UPØ3x16	x6	

UP11	
x12	UPØ4x20

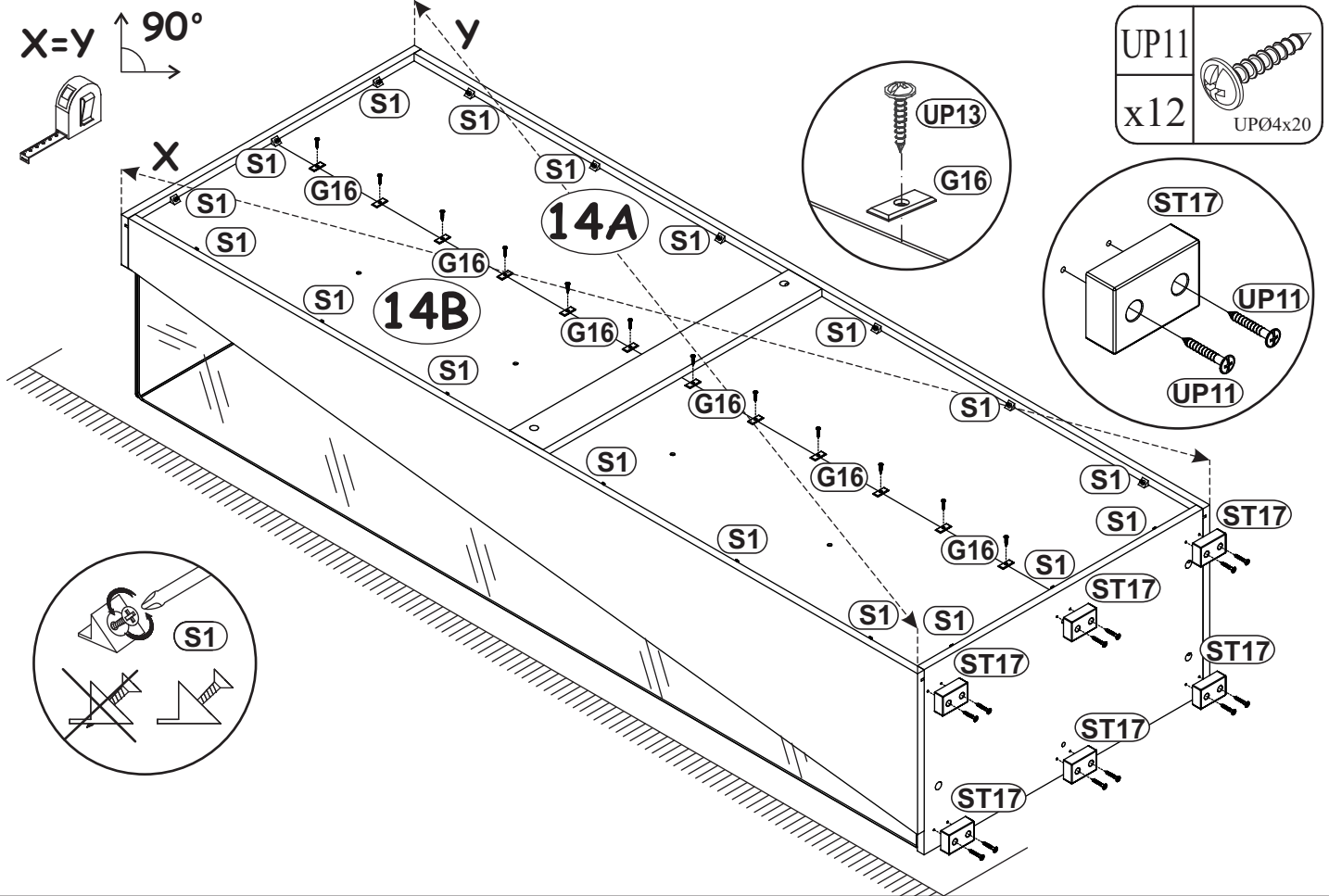

13

LED	
x1	x4

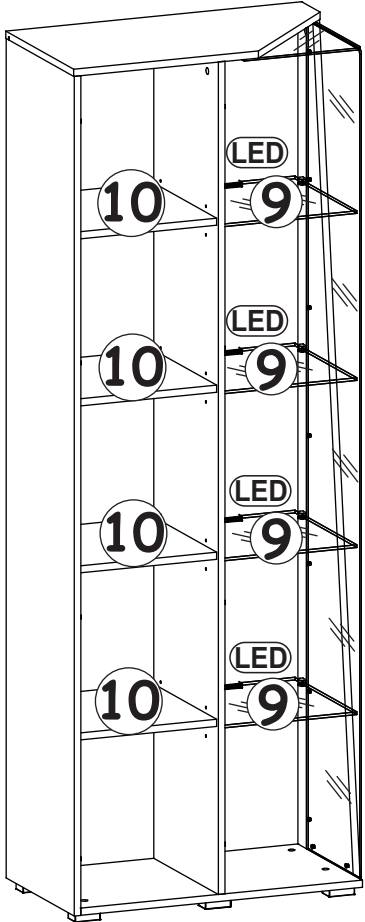
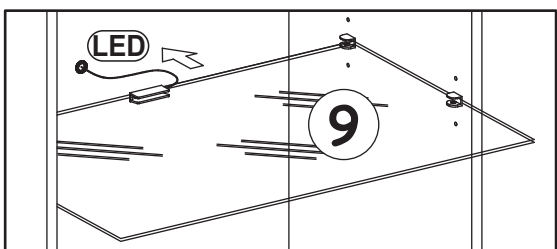
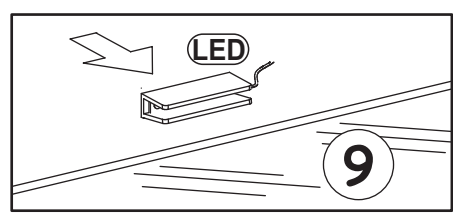

14

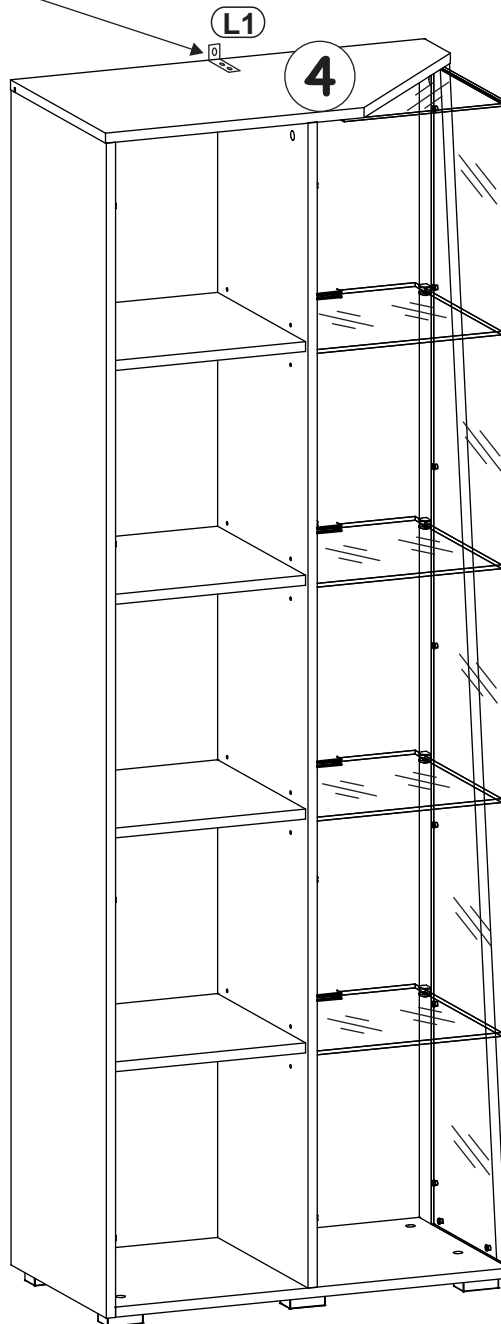
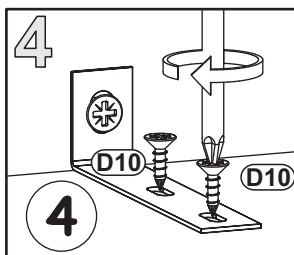
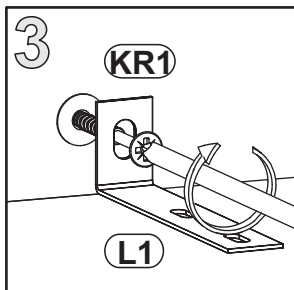
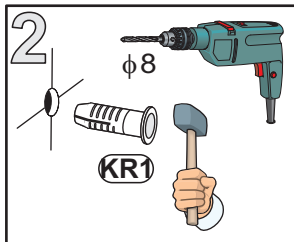
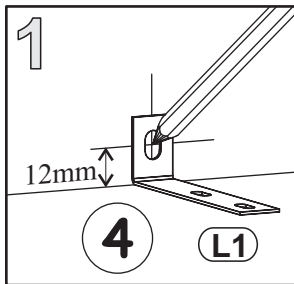
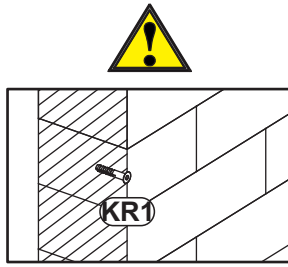
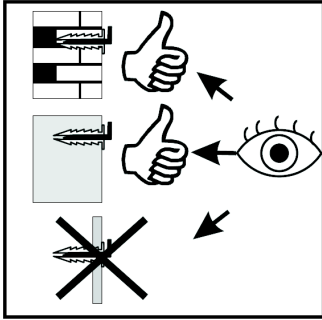
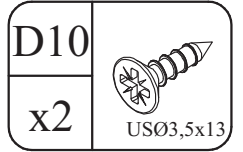
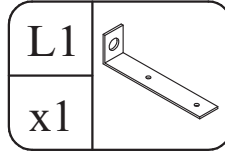
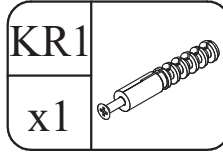

15

