

PL> INSTRUKCJA MONTAŻU
D >MONTAGEANLEITUNG
GB>ASSEMBLY INSTRUCTIONS

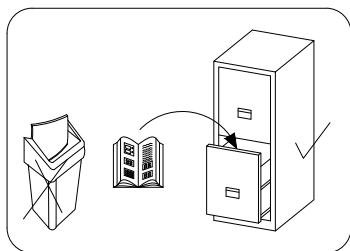

Czas montażu
 Montagezeit
 Time to assemble

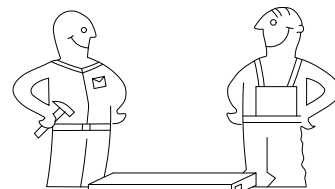
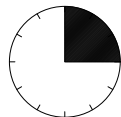

2 godz.
 2 hours
 2 zeit

Tools required narzędzia wymagane Werkzeuge erforderlich

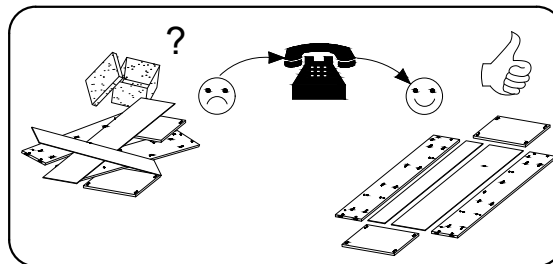
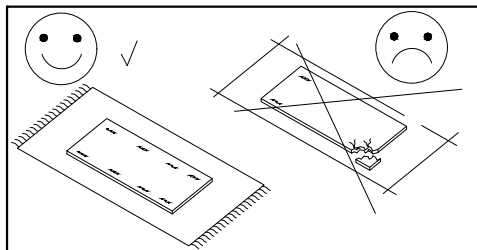
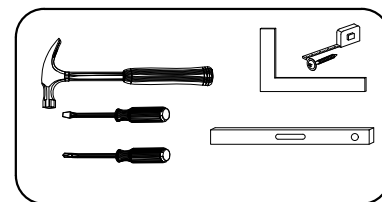

Nl>Schonmaken mag alleen worden gedaan met een doek of een licht vochtige handdoek.
 Gebruik geen schoonmaakmiddelen om te schuren.

PL>Czyszczenie należy wykonać wyłącznie za pomocą ściereczki lub lekko nawilżonego ręcznika.
 Nie stosować środków czyszczących do szorowania.

Szanowny kliencie, jeśli podczas montażu stwierdzisz uszkodzenie lub brak części, proszę podaj jej kod alfanumeryczny lub zaznacz ją na instrukcji montażu i prześlij wraz z protokołem reklamacyjnym

D >Bitte nur mit einem Staubtuch oder leicht feuchtem Lappen reinigen. Keine scheuerenden Putzmittel verwenden.

Sehr geehrter kunde, sollte ein teil fehlen oder beschädigt sein, kreuzen sie dies bitte deutlich auf der montageanleitung an und schicken sie die montageanleitung mit ein.

GB>Please only clean with a duster or a damp cloth. Do no use any abrasive cleaners.

Dear customer, should there be any piece missing or damaged, kindly mark this piece clearly on the attached assembly instructions and return them to us.

Karta serwisowa /Service Karte /Service card

AKCESORIA / ZUBEHÖR / ACCESSORIES

8.0x30 D 24	 A 22	Ø15x12 B 22	 X 22	4.0x16 H 8	3.0x16 H4 4
 M1 4	 TY 2	 Z 4	 L 4	4.0x20 H2 16	

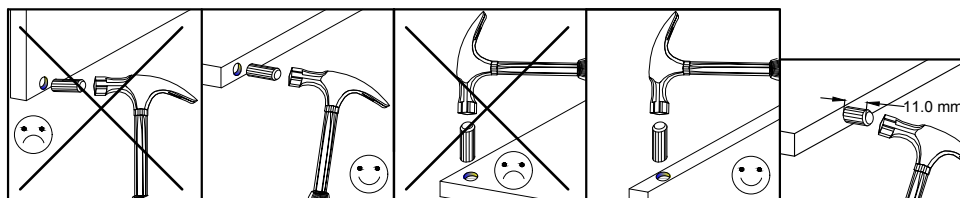

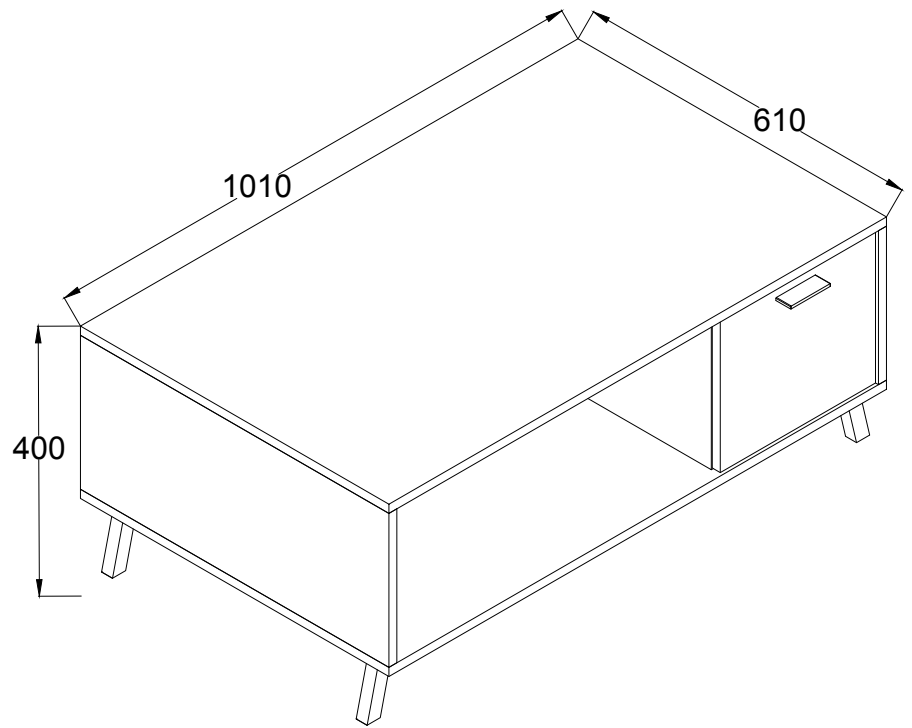



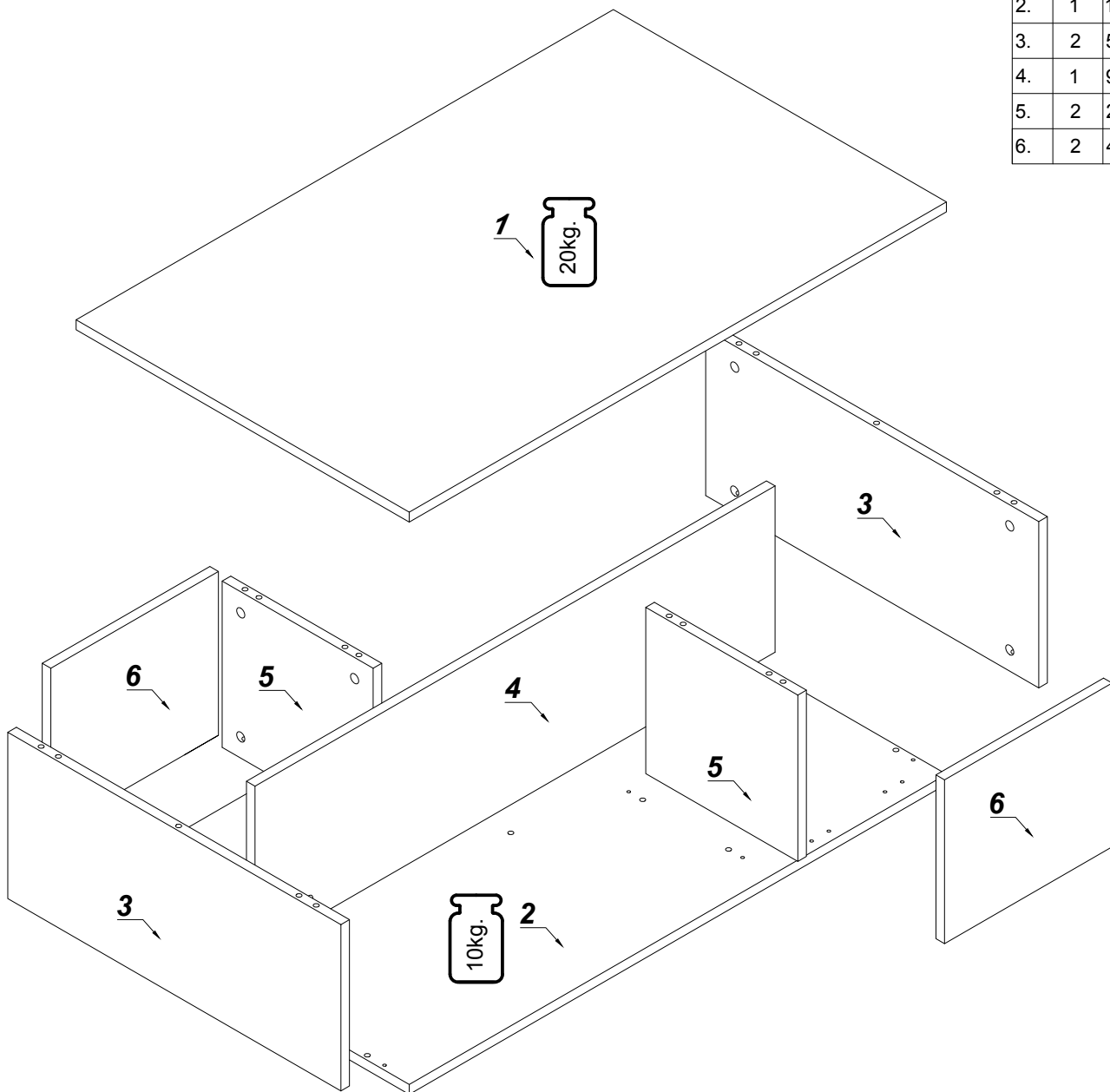

1.	1	1004	604	22
2.	1	1001	600	16
3.	2	550	242	16
4.	1	968	242	16
5.	2	267	242	16
6.	2	400	236	16

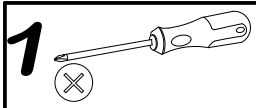



mm



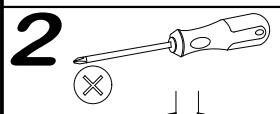
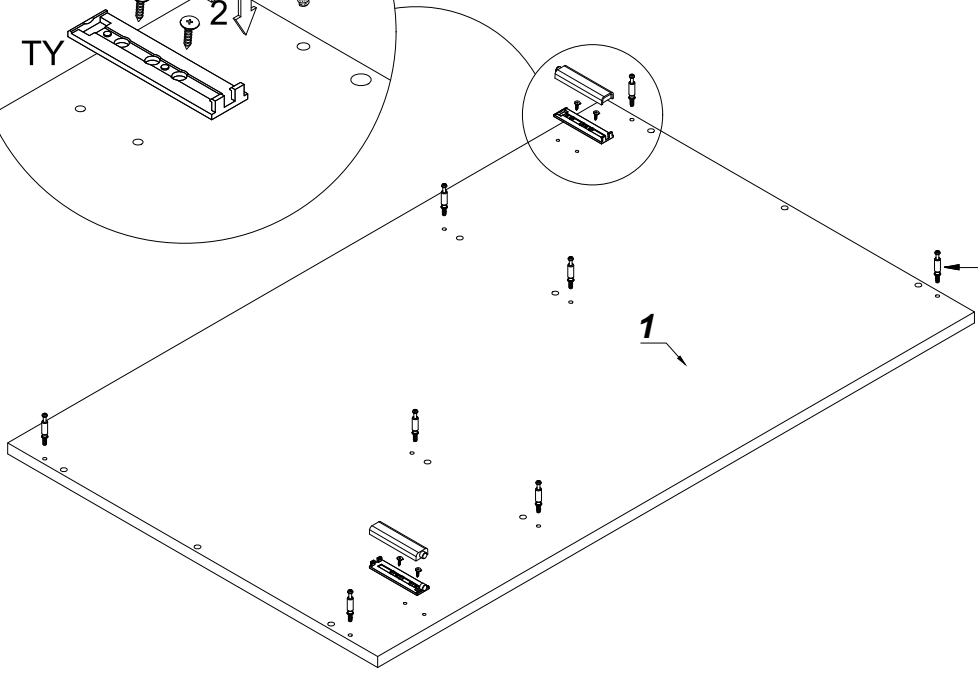
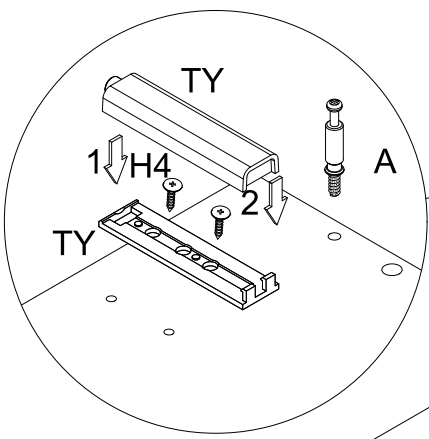

 TY 2	 KR 8
 F1 3	



 L 4	 H2 16	 A 4	 M1 4
 KR 10			

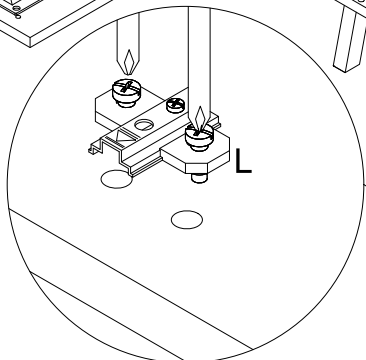
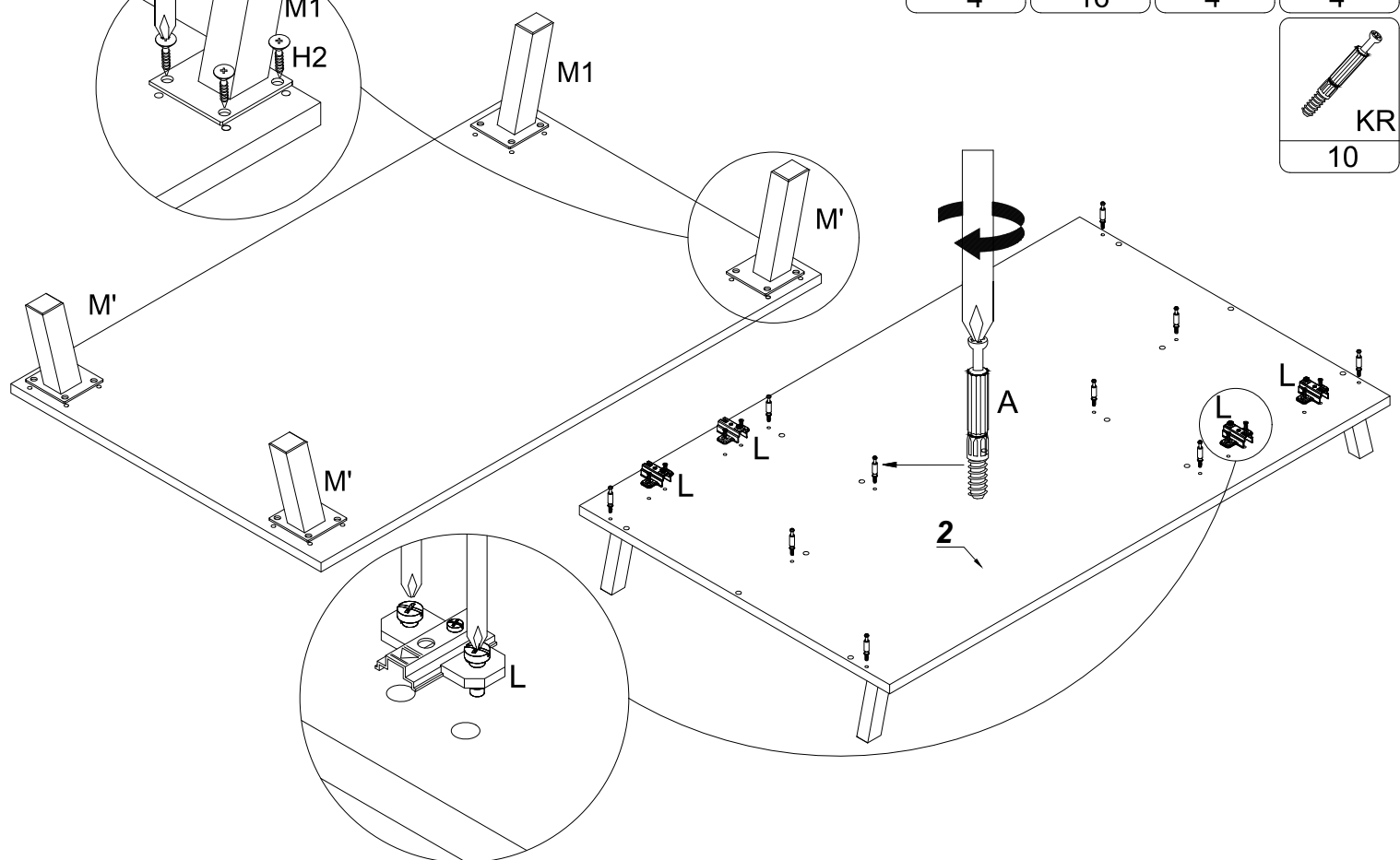
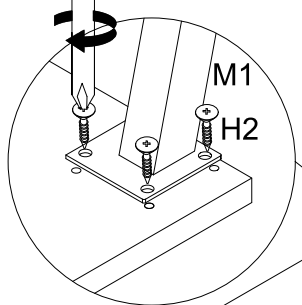

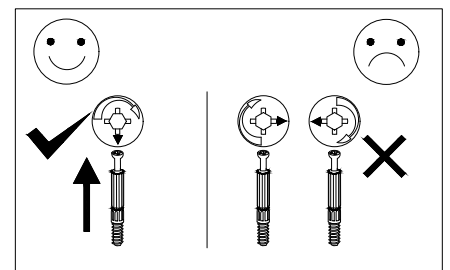
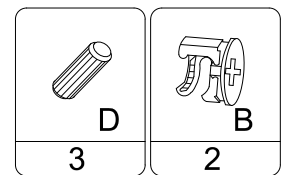
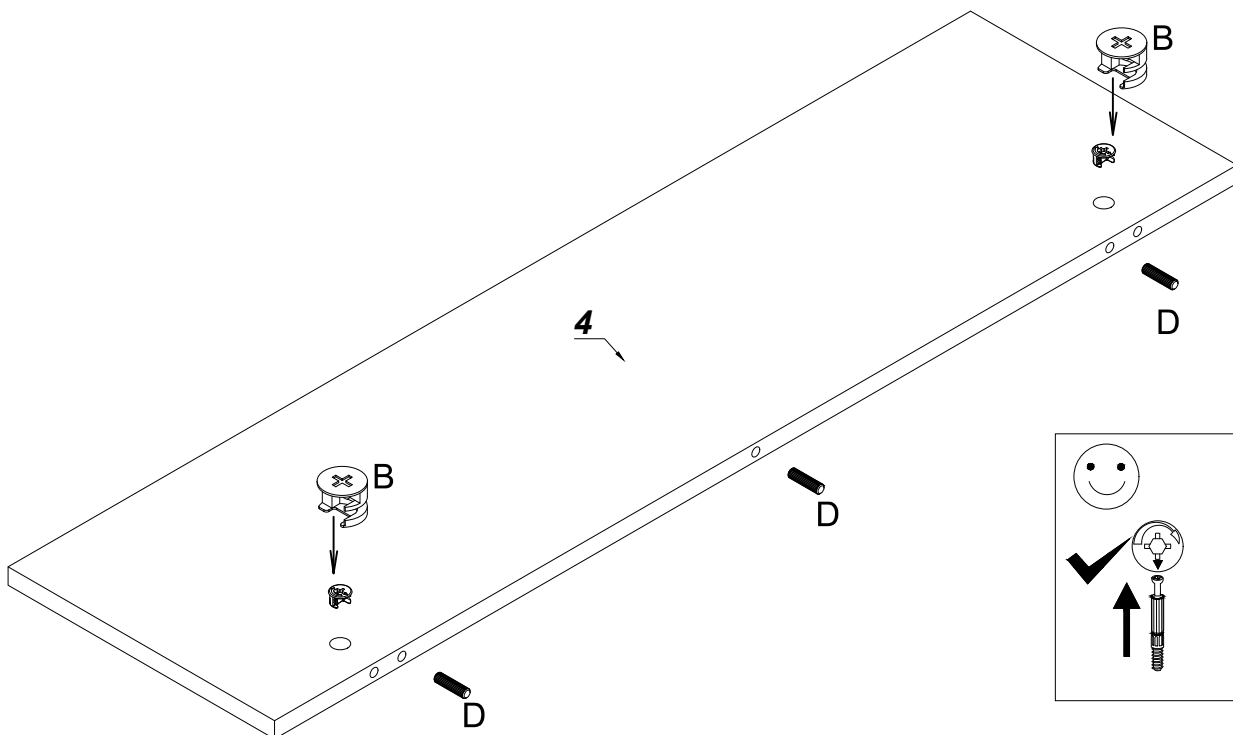
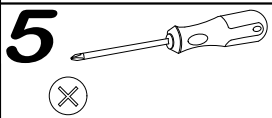
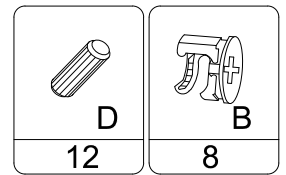
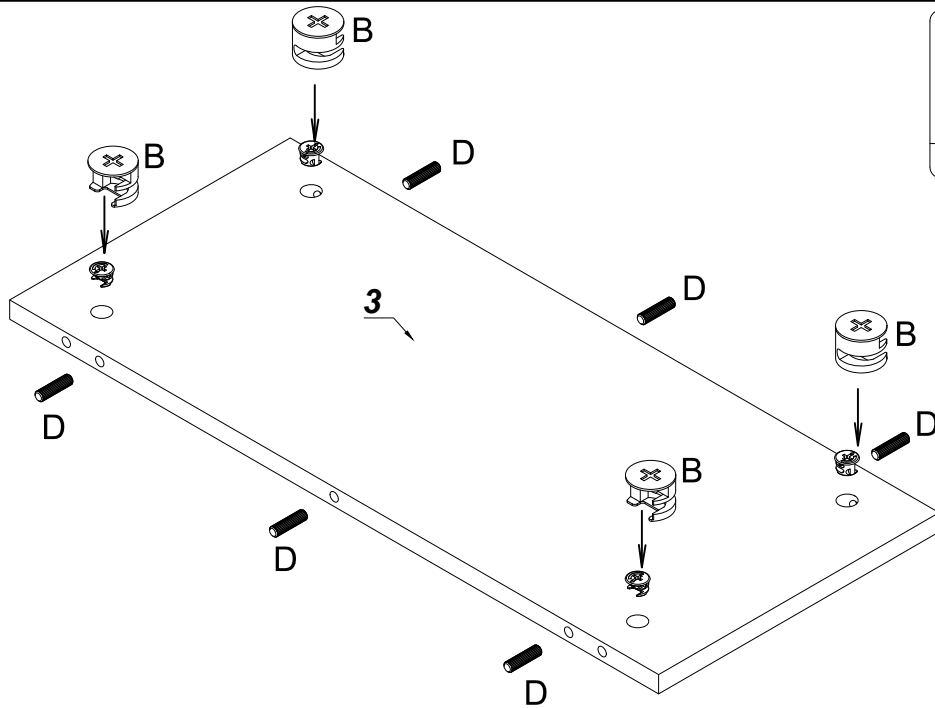
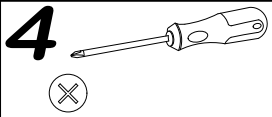
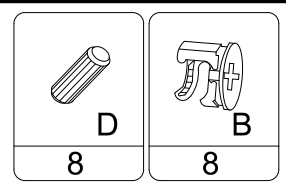
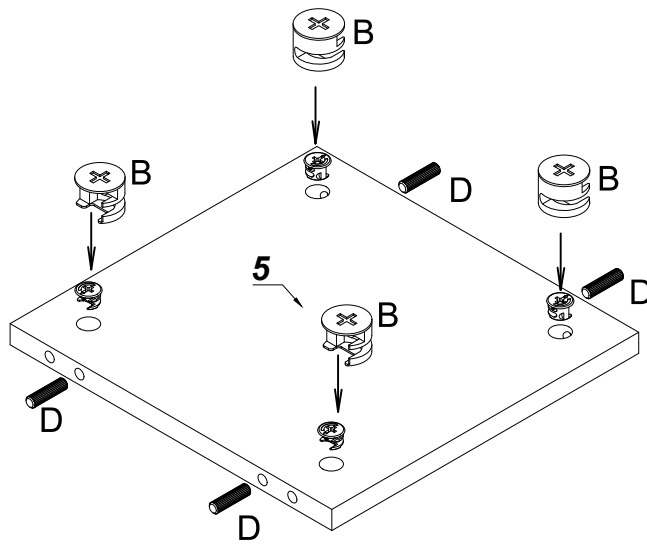
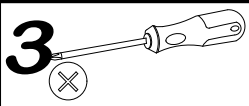

6

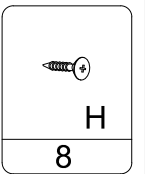
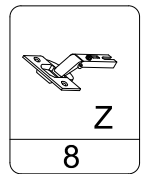
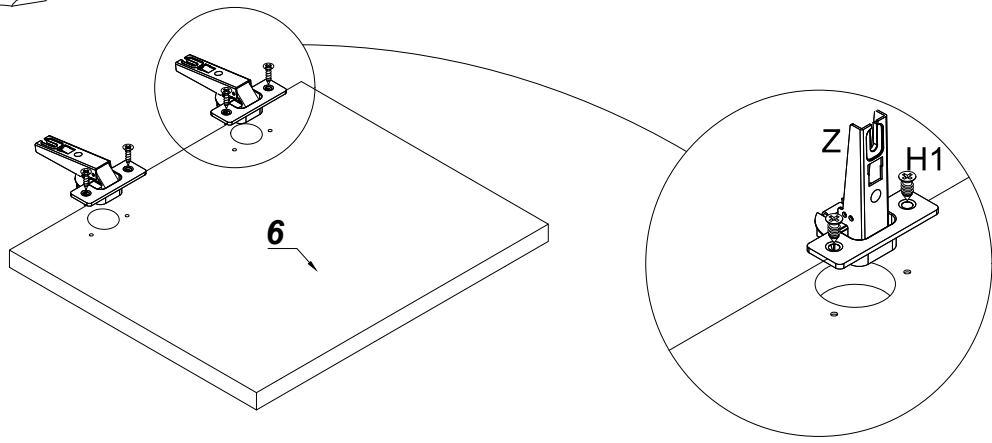
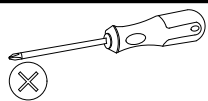

7

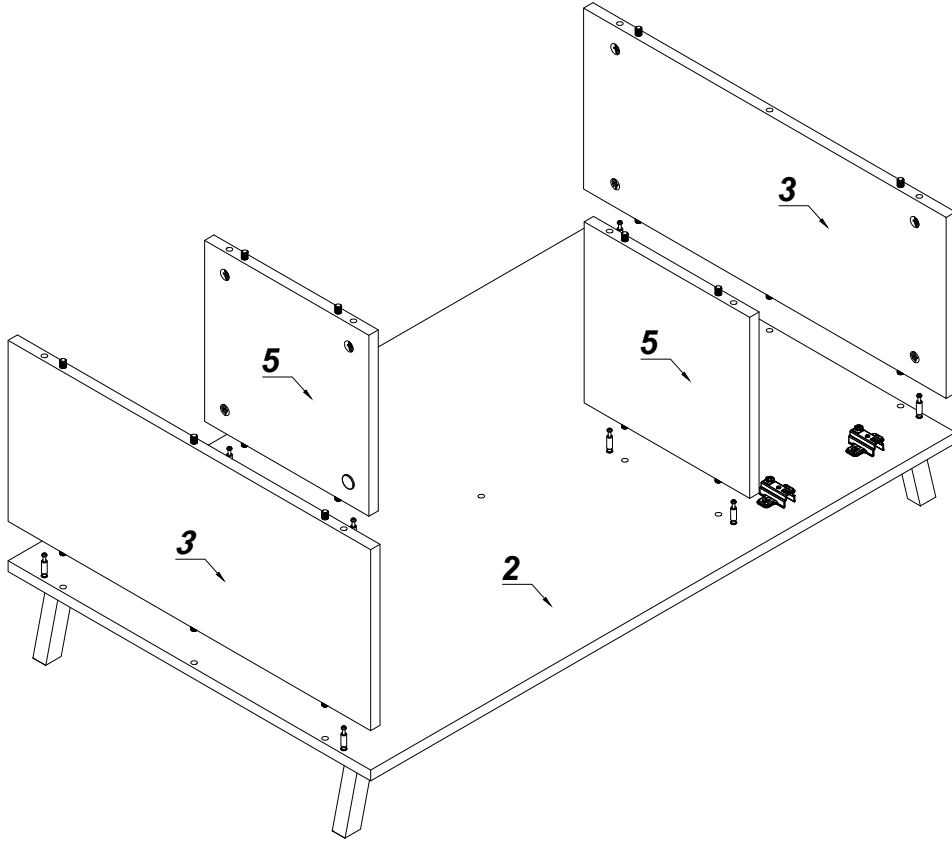
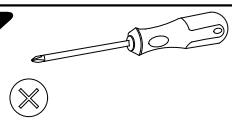

8

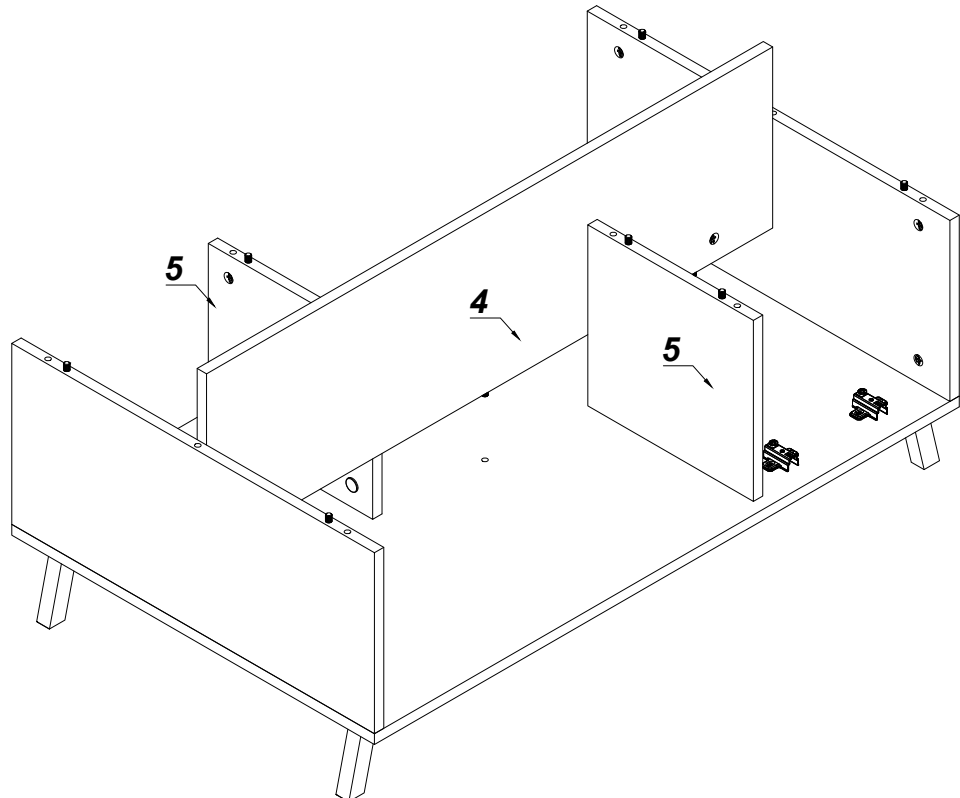
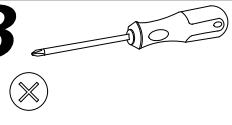

9

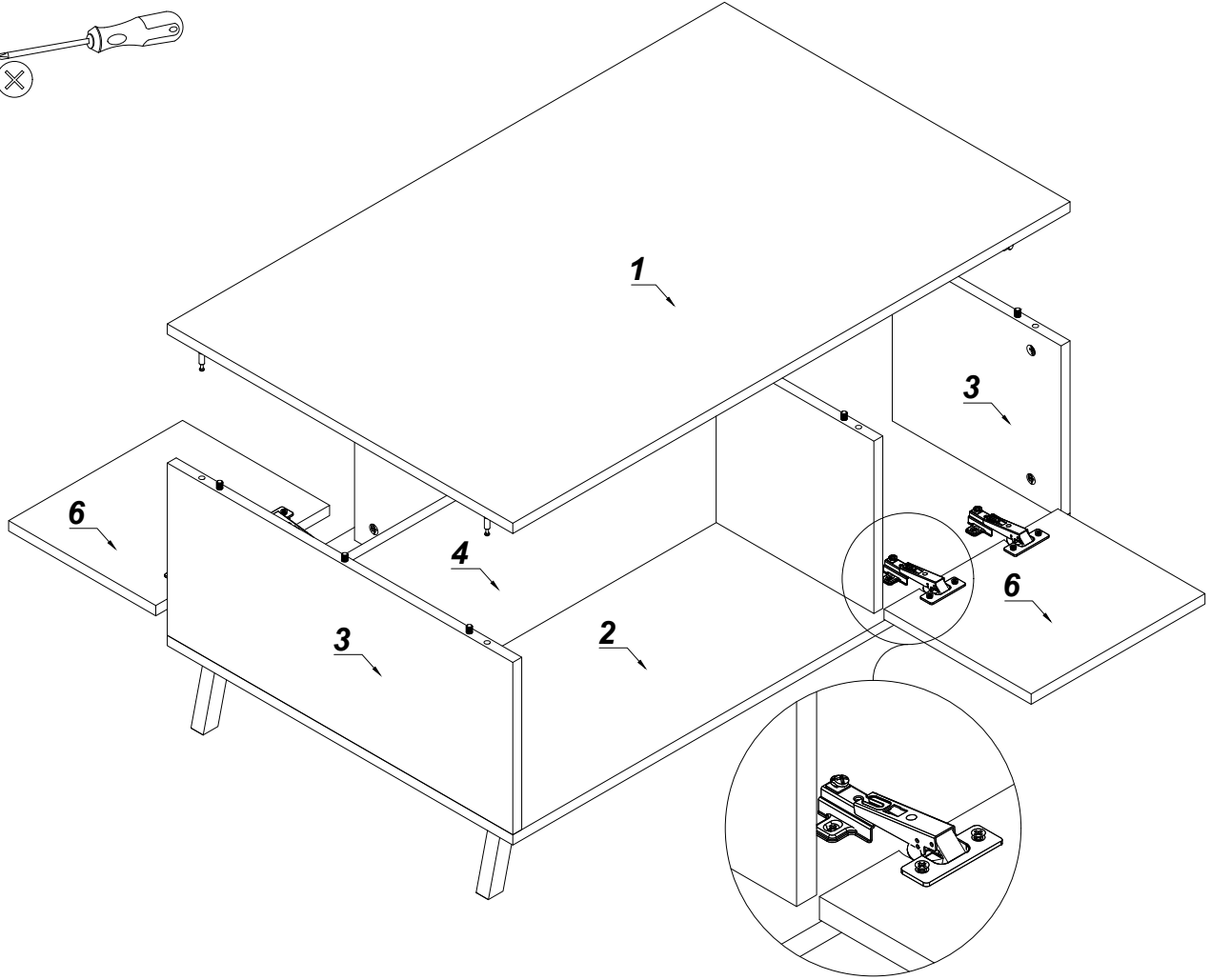
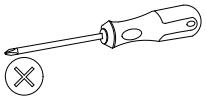

10

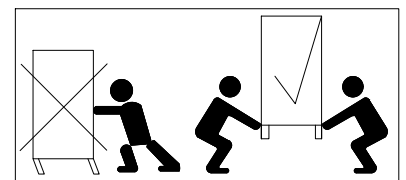
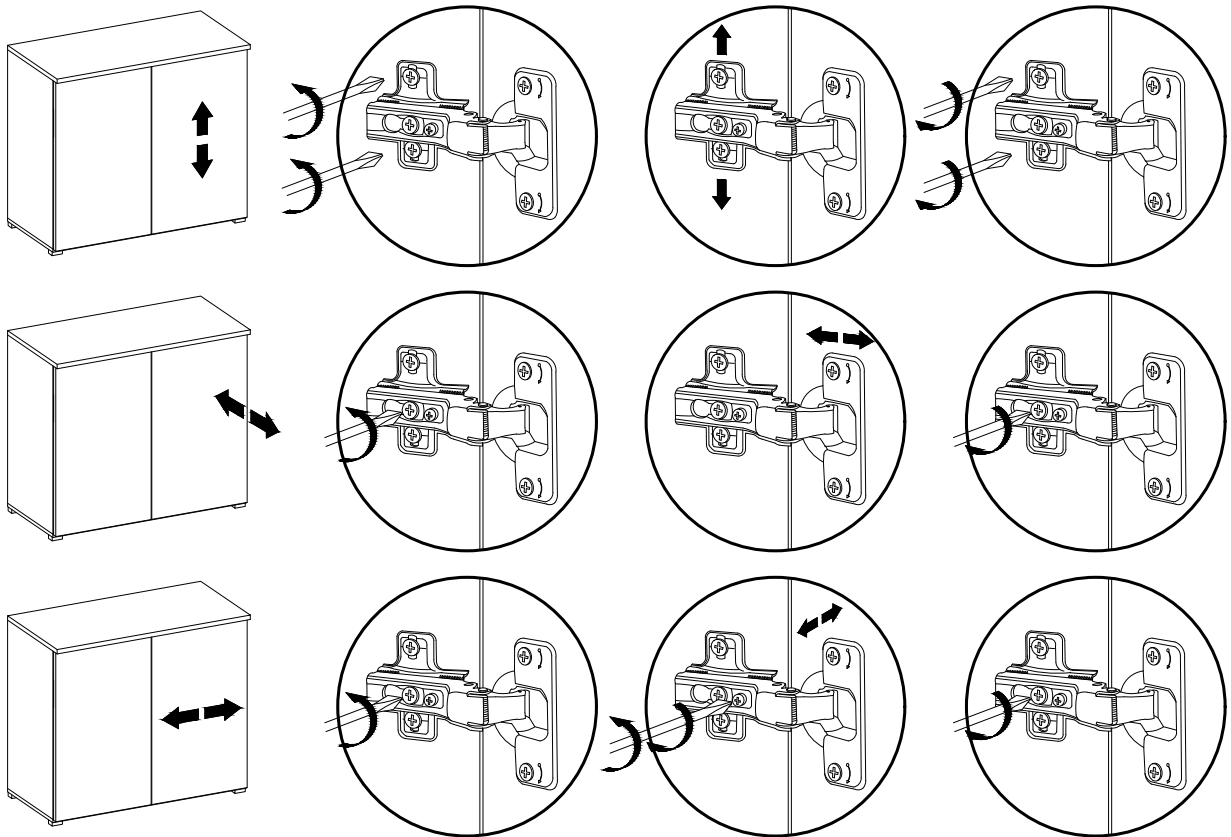

ZASADY UŻYTKOWANIA I KONSERWACJI MEBLI GRUNDSÄTZE ZUR MÖBELNUTZUNG UND PFLEGE GUIDLINES FOR FURNITURE USE AND MAINTENANCE

PL

1. Meble należy użytkować w pomieszczeniach suchych przed szkodliwymi wpływami atmosferycznymi .
2. Montaż mebli należy przeprowadzić zgodnie z instrukcją montażu mebla.
3. Miejsce montażu mebla w miarę możliwości powinno odbywać się jak najbliżej miejsca docelowego.
4. Meble przy ustawieniu należy wypoziomować
5. Przemieszczanie mebli winno być dokonywane poprzez przenoszenie bez dodatkowego obciążenia. Ciągnięcie przesuwanie mebli grozi trwałym nieodwracalnym uszkodzeniem .Podczas przenoszenia należy chwycić za element pionowe. Boki nogi . Nie wolno chwycić za części poziome które mogą być podatne na uszkodzenia tj. blaty szuflady .
6. Nie należy nadmiernie obciążać mebli ,grozi to ich trwałym uszkodzeniem
7. W trakcie użytkowania mebli należy okresowo sprawdzać stan połączeń mimosrodowych zaisów i przewodników do zawiasów.
8. Powierzchnie należy czyścić tylko środkami do pielęgnacji mebli.

D

1. Die möbel sind nur in trockenen räumen unterzubringen wo sie gegen schädliche witterungseinflüssen geschützt werden können
2. Die montage von einzelementen ist gemäß montageanleitung durchzuführen
3. Der montageplatz der möbel sollen die möbelstücke horizontaliert werden.
5. Die möbel sind nur ohne zusätzliche belastung zu bewegen beim verschieben und am-boden-ziehen können dauerhafte schäden entstehen bei der bewegung soll immer nur an senkrechten elementen wie seitenflächen oder beinen gehalten werden .waagrechte bauteile wie platten schubladen, dürfen dabei nicht beansprucht werden weil sie beschädigungsanfällig sein können.
6. Die möbel dürfen nicht übermäßig belastet werden denn eine überbelastung kann dauerhaften schäden verursachen.
7. während der möbelnutzung soll notfalls der zustand der außermittigen verbindungen kontrolliert werden möbeloberflächen sind nur mit speziellen dazu geeigneten möbelpflegemitteln zu reinigen.

GB

1. Furniture should be used in rooms which are dry and protected against the harmful influences of weather conditions.
2. Furniture should be assembled in accordance with the assembly manual.
3. Furniture should be assembled as close as possible to it's intended final location.
4. While positioning the furniture make sure it is levelled
5. Furniture may be moved only by lifting and carrying it over when emptied of its contents. Pushing it over or pulling it along may ruin the furniture permanently. While carrying the furniture over it must be held by its vertical elements , i.e side panels or legs. Furniture cannot be held by it's horizontal elements prone to destruction, i.e desktops drawer, etc..
6. furniture should not be overloaded as this may ruin it permanently.
7. While using the furniture ,the state of the connections between it's elements should be checked if necessary.
8. furniture surface must be cleaned only with furniture maintenance formulas.

NL

1. De meubels dienen gebruikt te worden in droge ruimtes tegen schadelijke weersomstandigheden.
2. Meubelmontage dient te geschieden in overeenstemming met de meubelmontagehandleiding.
- De 3e plaats van meubelmontage moet, indien mogelijk, zo dicht mogelijk bij de bestemming zijn.
4. meubels moeten waterpas staan bij het plaatsen
5. Het verplaatsen van meubels dient te geschieden door ze zonder extra belasting te verplaatsen. Trekken het verplaatsen van het meubel kan blijvende onherstelbare schade veroorzaken verticale elementen. Zijkanten van het been. Pak de horizontale onderdelen die mogelijk beschadigd kunnen raken, zoals werkbladen, niet vast lades.
6. Overbelast het meubel niet, het kan permanent beschadigd raken
7. Terwijl het meubilair in gebruik is, moet de staat van de excentrische verbindingen van de scharnieren en geleiders periodiek worden gecontroleerd scharnieren.
8. Oppervlakken mogen alleen worden gereinigd met onderhoudsmiddelen voor meubels.

