

ELENA 3D

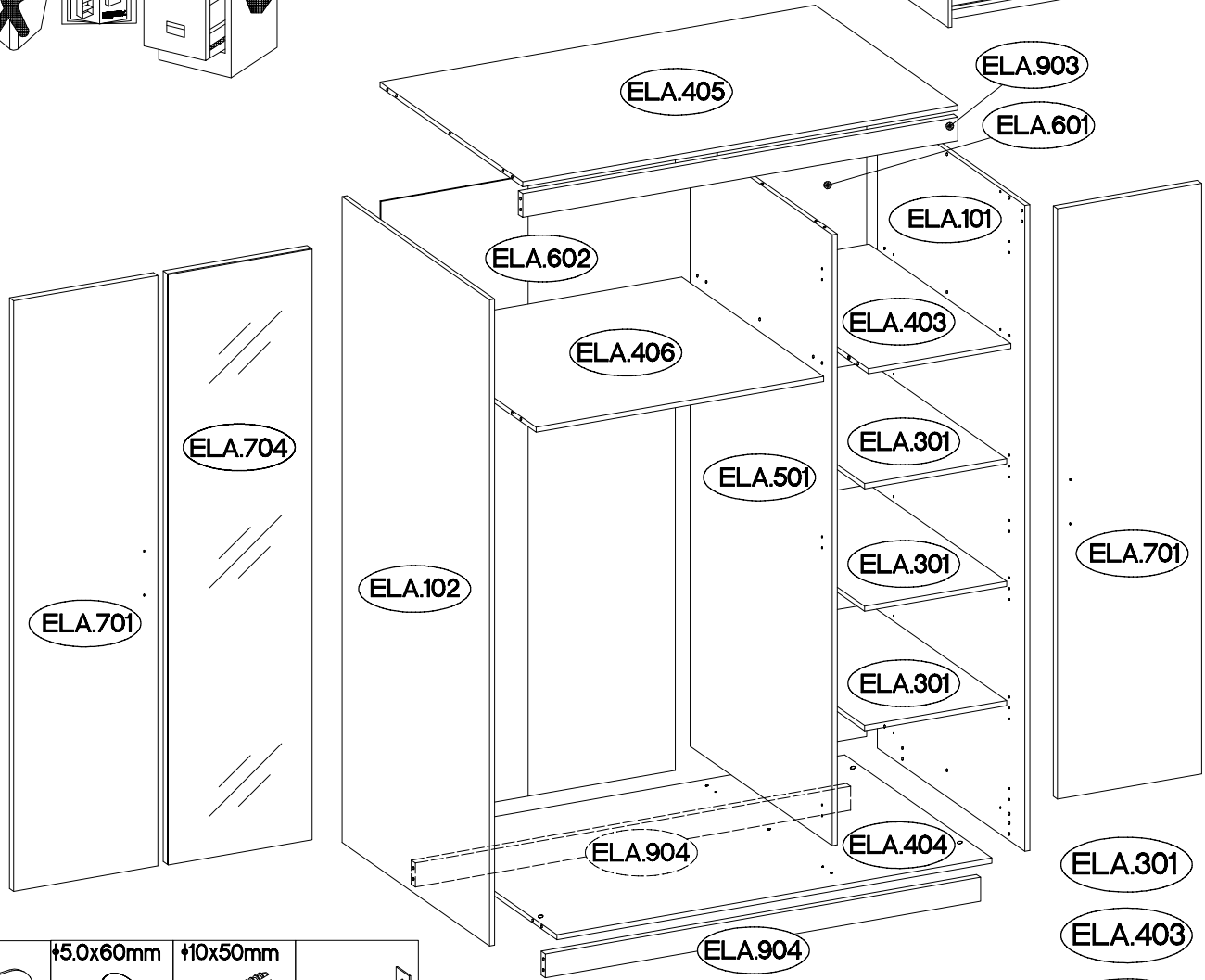

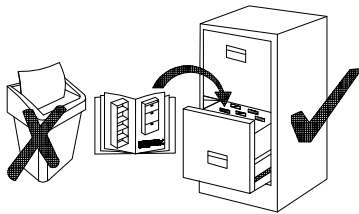

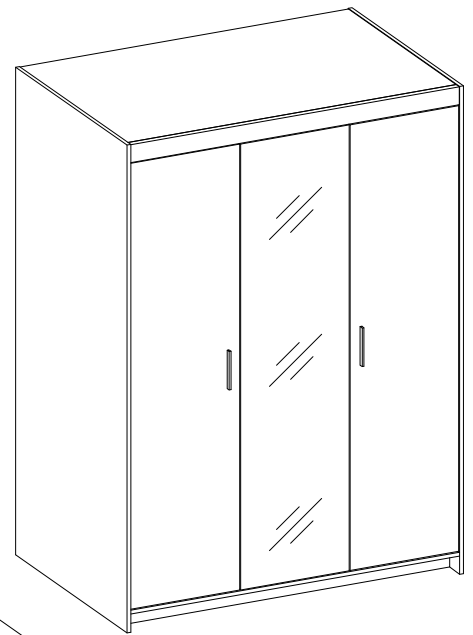

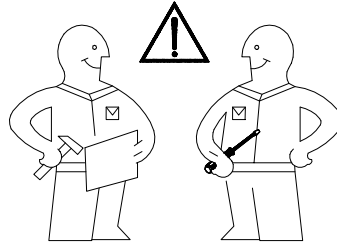
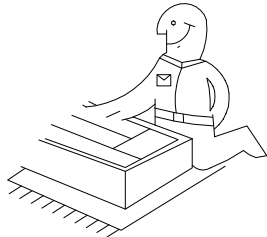
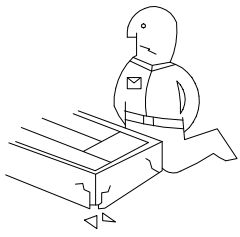



ELA.301
 ELA.403 = max. 5kg
 ELA.406

	+5.0x60mm P12	+10x50mm O7	
14	1	1	1

+35/16mm G2	H=0 H	+3.5x13mm P5	L=56mm D4	6.5x48x16 F2	L=85mm J2		J3	+35/9mm G1	+4.0x16mm P1	T3
6	9	22	2	4	1	2	12	3	4	2
+15/12mm C	E	+8x30mm A	L=20mm D2	L=128mm S11	+4.0x27mm R1	+3.0x20mm P7	+15x5mm F4			
20	20	42	16	2	4	66	2			

P-ISM-ELA-05

1

L=56mm 	∅15/12mm 	∅8x30mm 	L=20mm 	∅15x5mm 	∅4.0x16mm 		6.5x48x16 
D4	C	A	D2	F4	P1	T3	F2
2	20	42	16	2	2	2	4

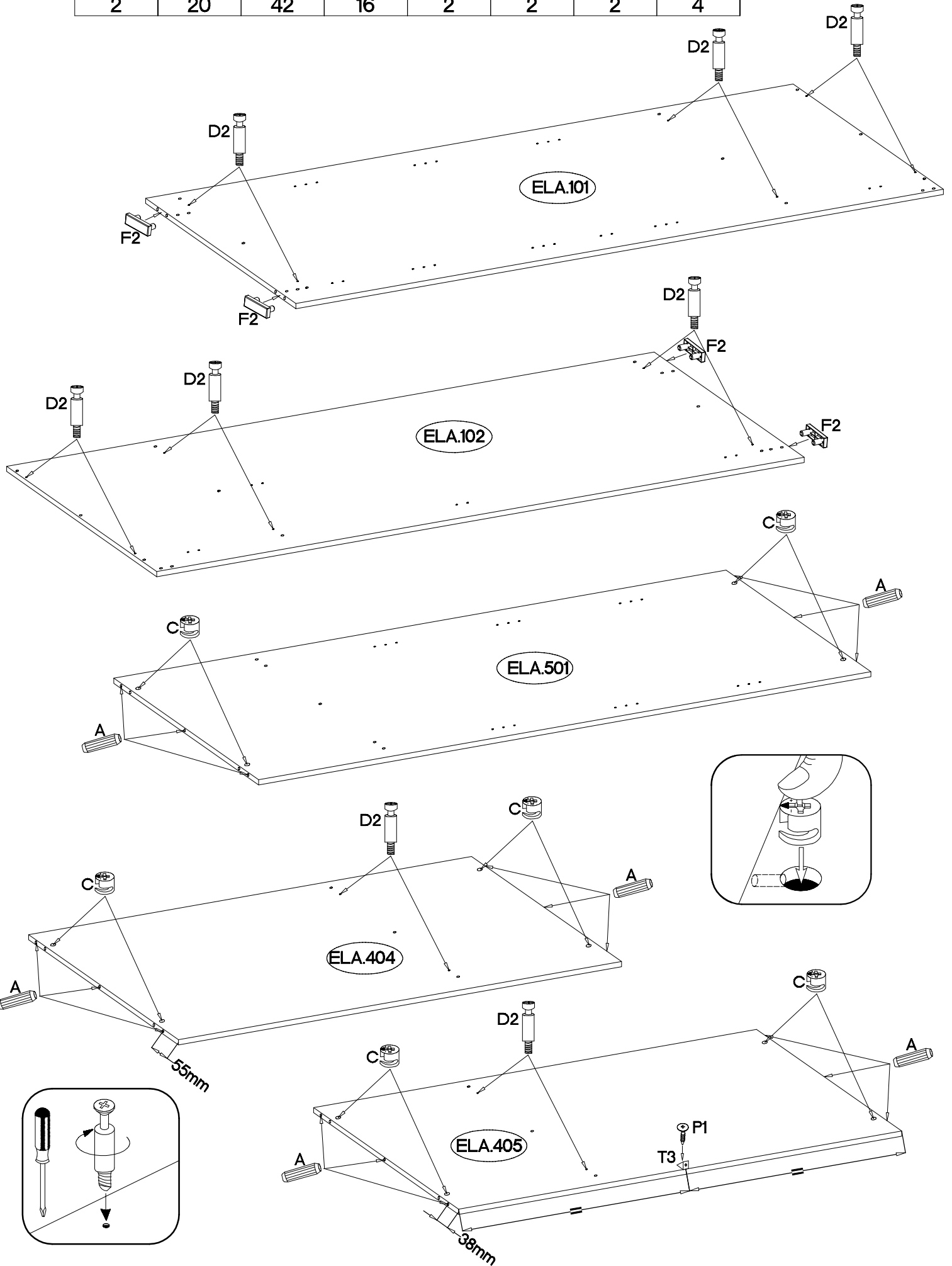

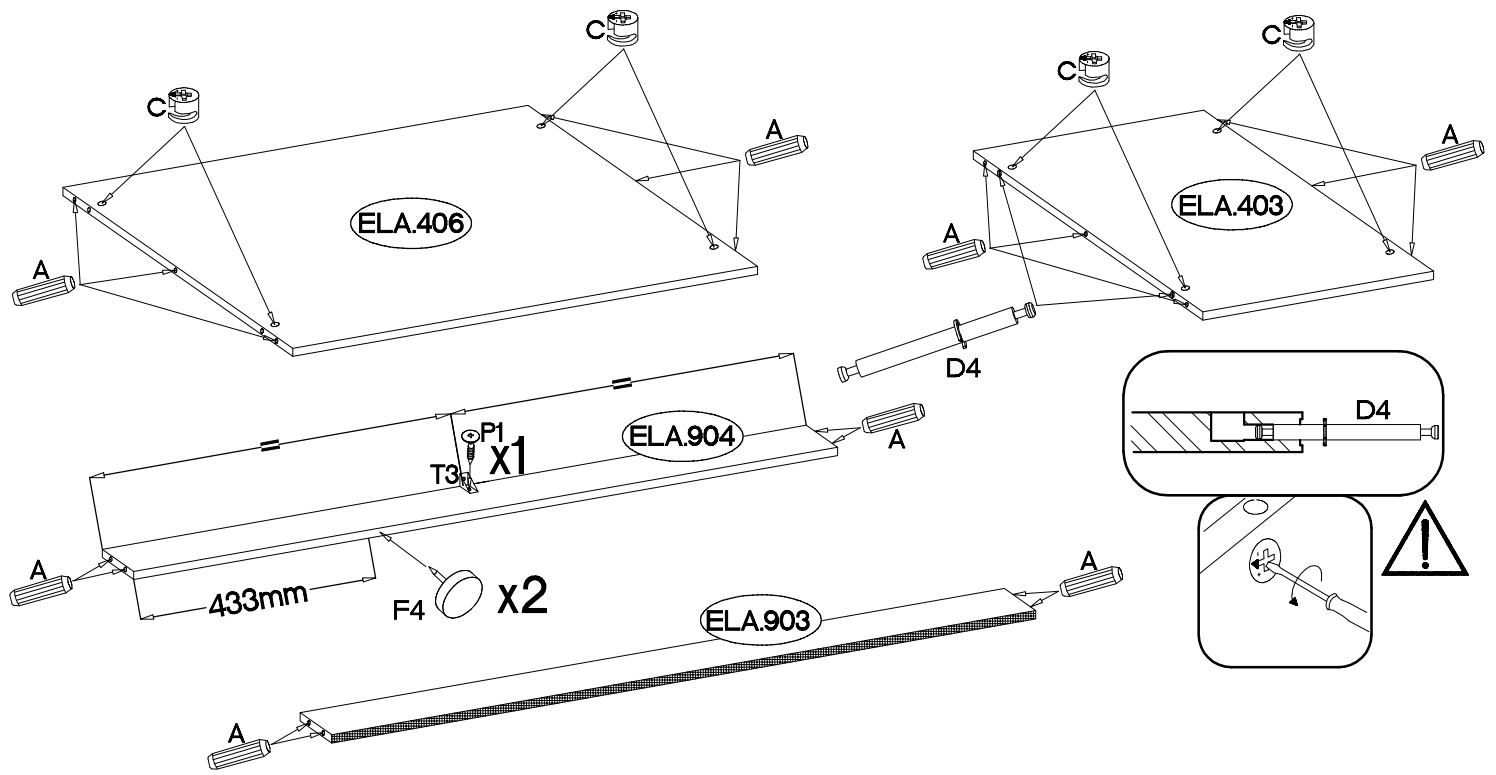

2

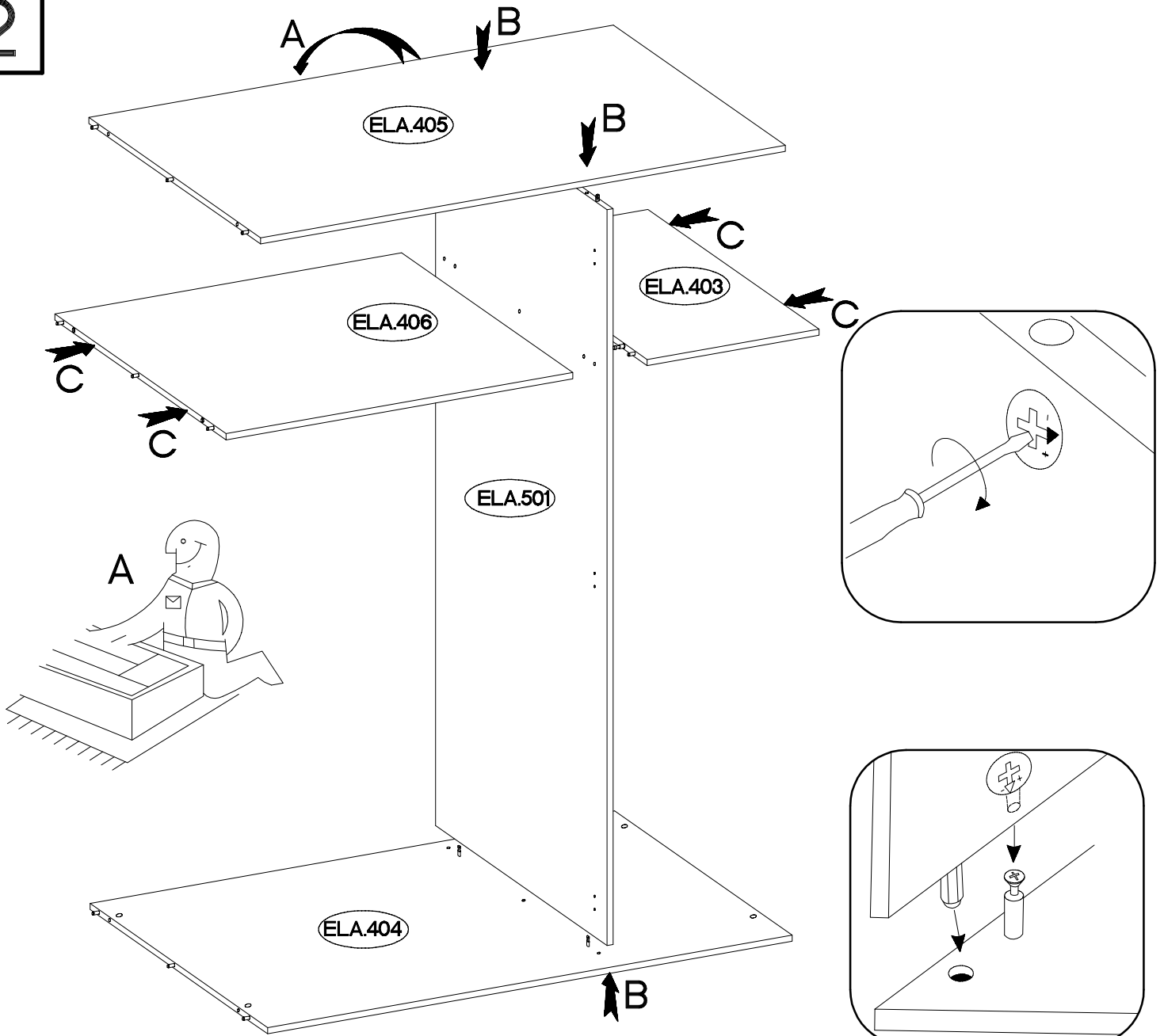

3

4.0x16mm



P1

2



ELA.903

ELA.101

ELA.102

ELA.904

ELA.904

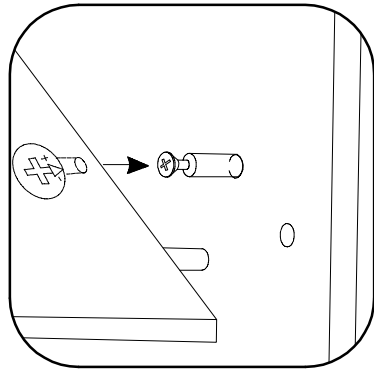
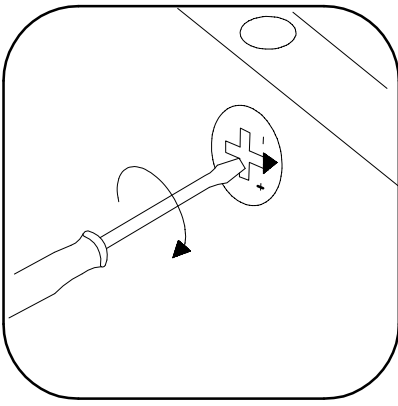
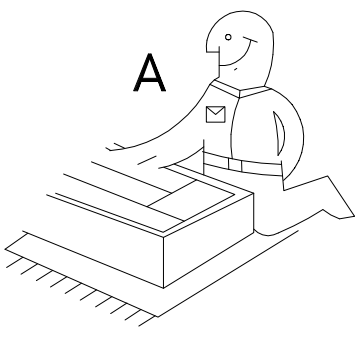
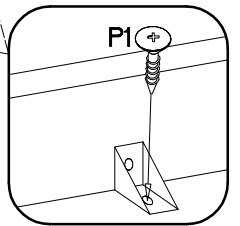

4



	±3.0x20mm
L2	P7
14	66

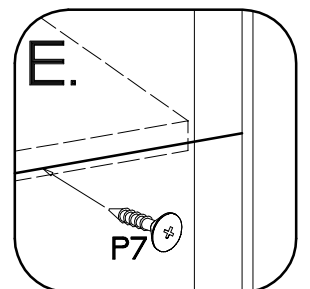
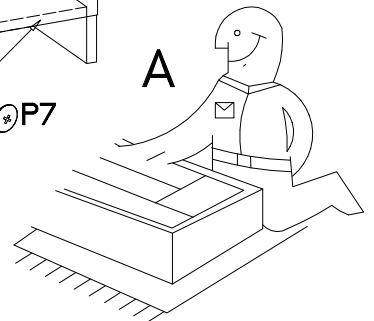
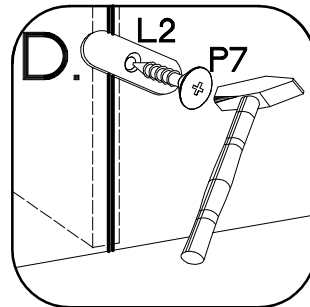
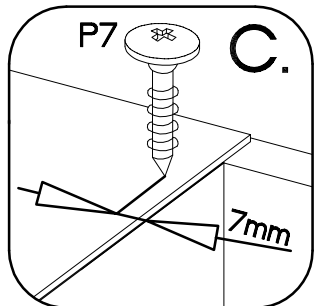
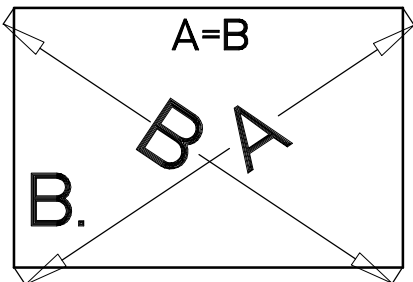
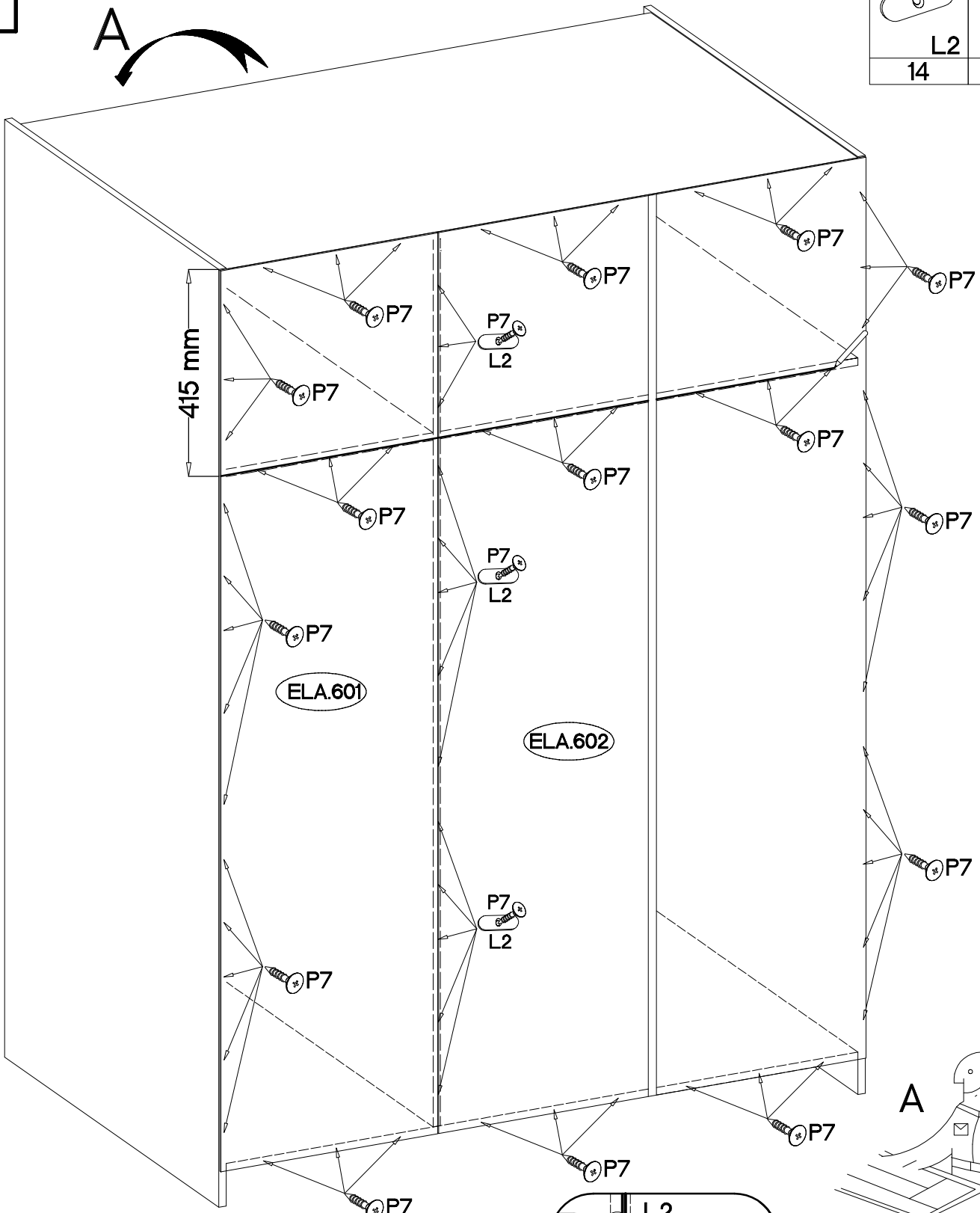



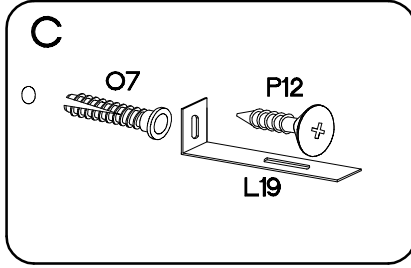
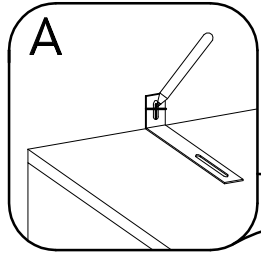
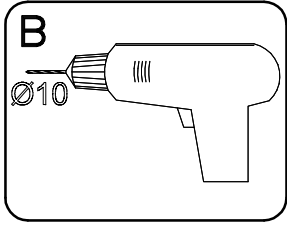

5

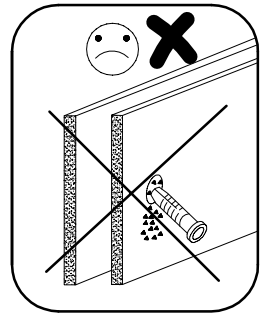
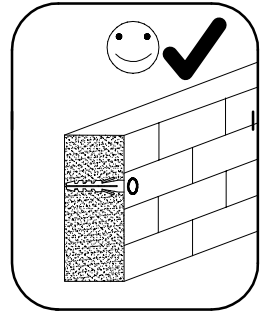
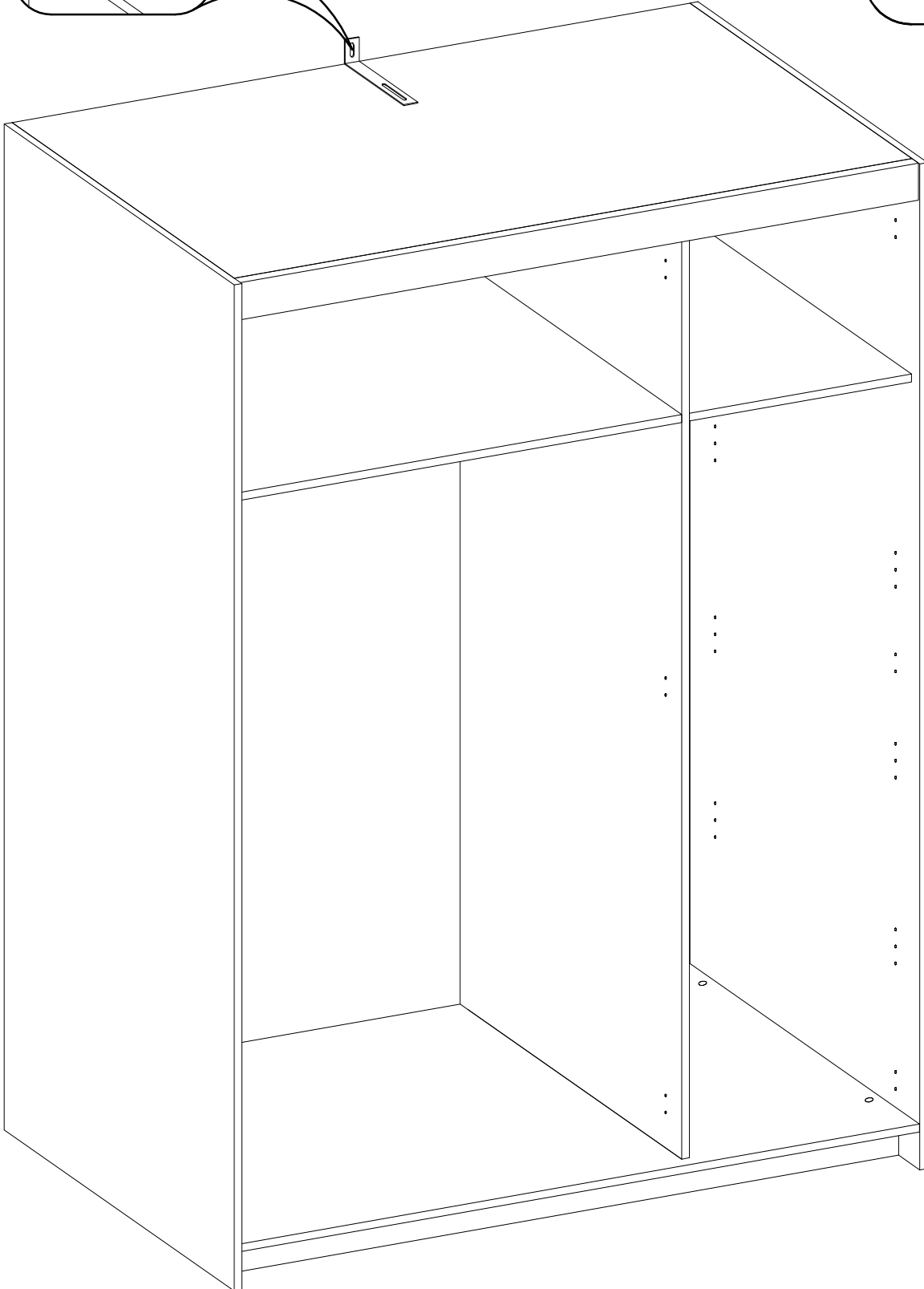
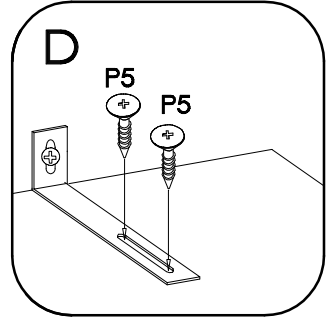

±5.0x60mm	±10x50mm		±3.5x13mm
P12	O7	L19	P5
1	1	1	2





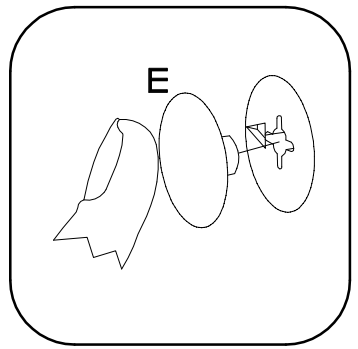
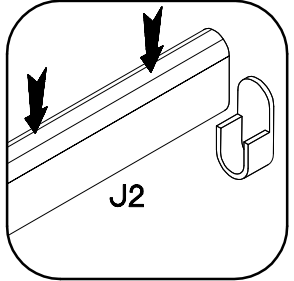
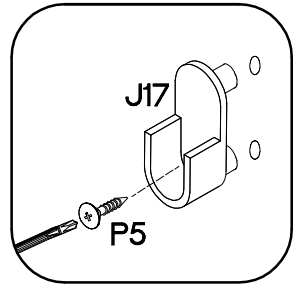
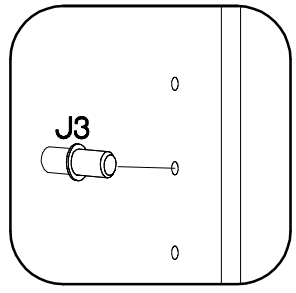
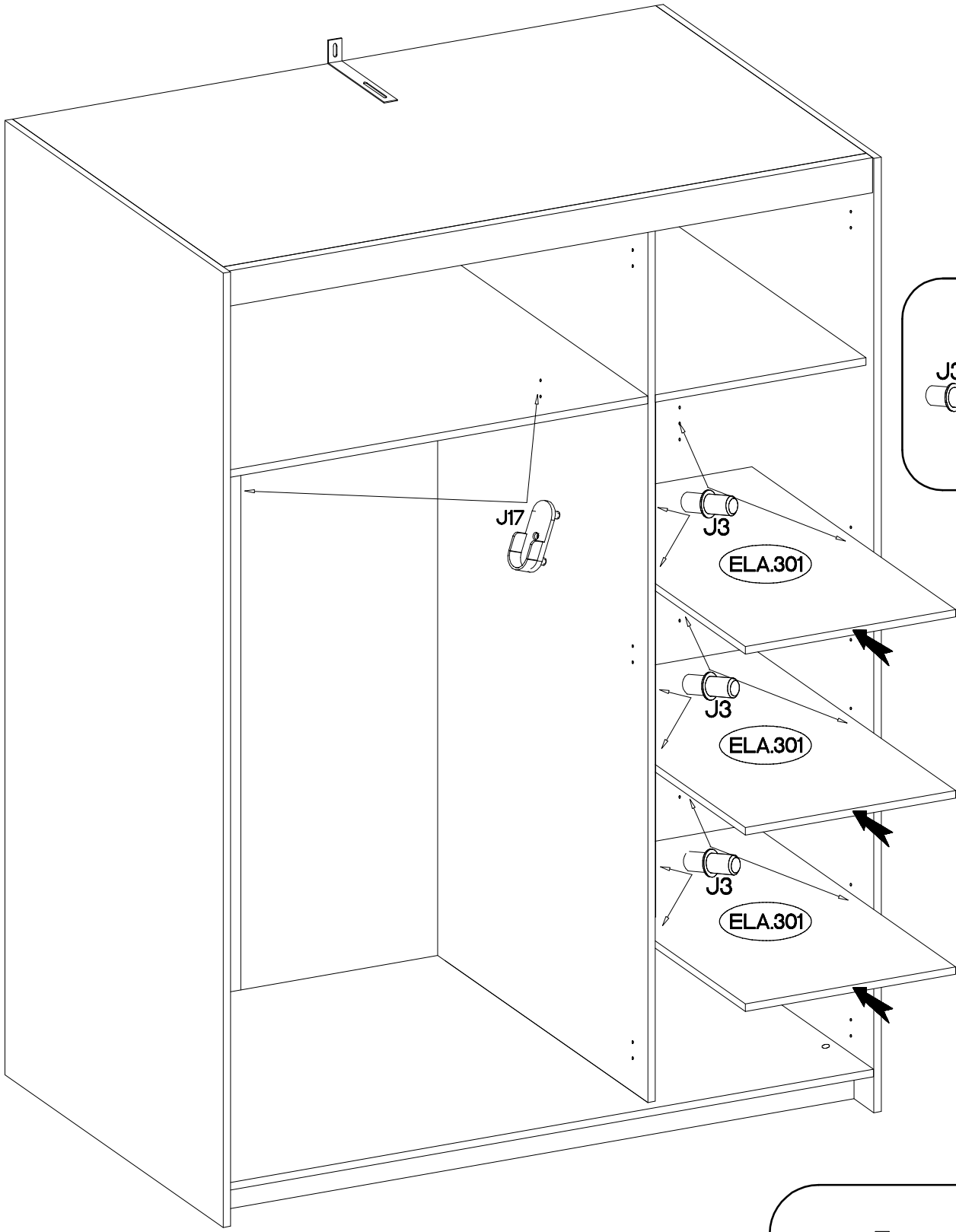

6

$\varnothing 3.5 \times 13 \text{mm}$  P5	L=851mm  J2	 J17	 J3	 E
2	1	2	12	20



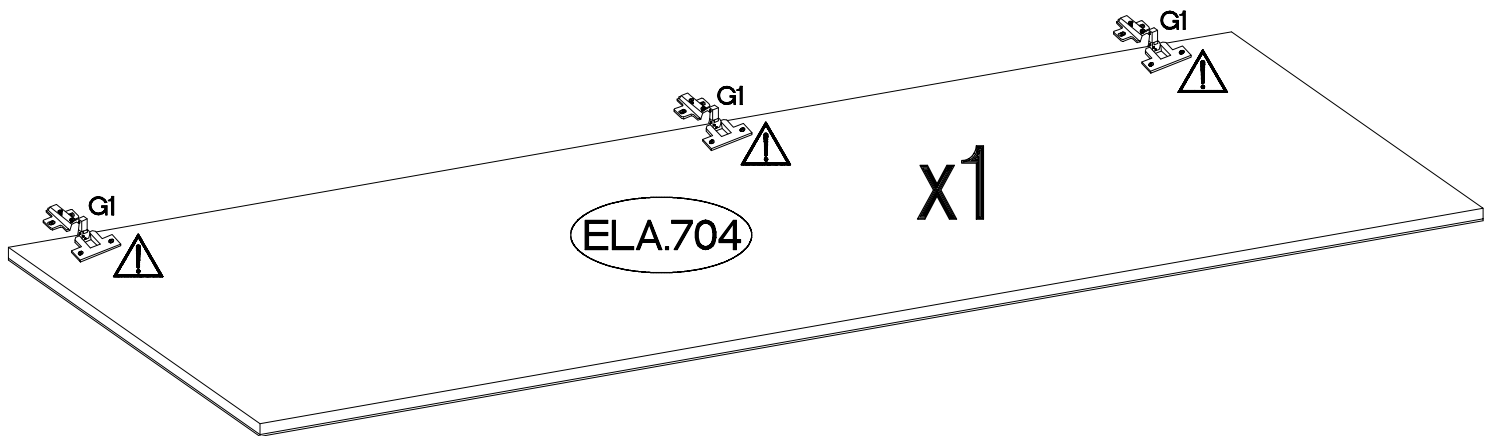
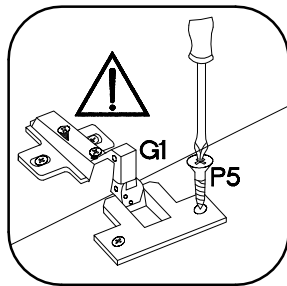
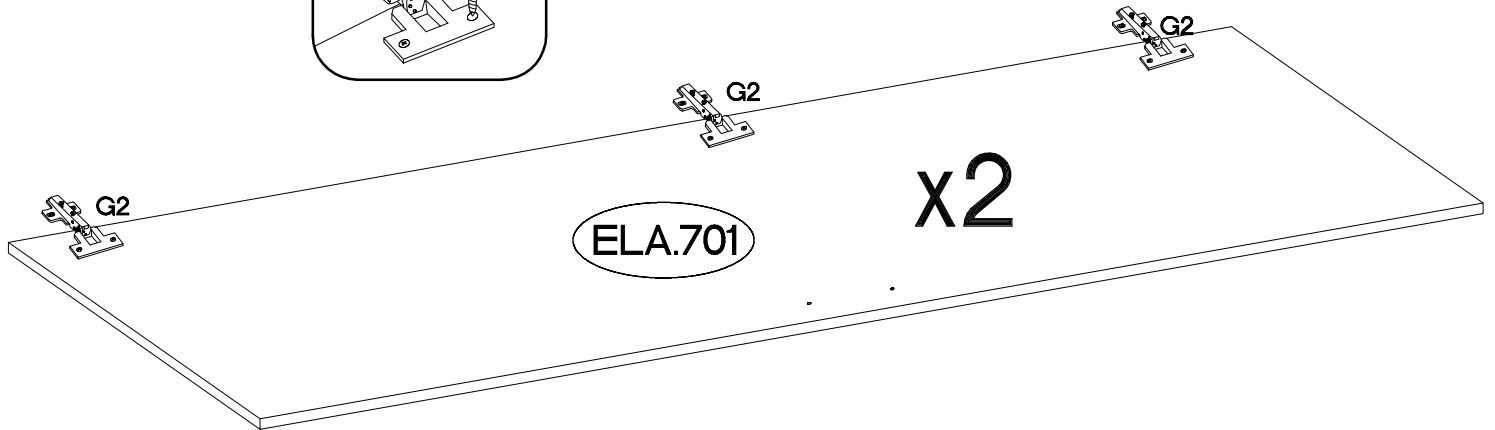
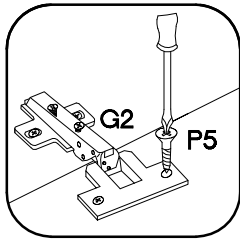
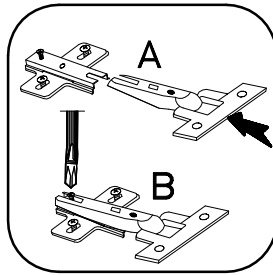

7

±35/16mm  G2 6	H=0  H 9	±3.5x13mm  P5 18	±35/9mm  G1 3
---	---	---	--

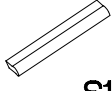

8

L=128mm	4.0x27mm
	
S11	R1
2	4

